



2232 CR 719, Berryville, AR 72616
Phone: 870-545-3886 Fax: 870-545-3894

www.idpa.com

Competition and Equipment Rules of the International Defensive
Pistol Association, Inc., adopted 10/26/96, effective 3/1/2015.
Copyright © 1996 -2015 International Defensive Pistol Association,
Inc., all rights reserved.

V1.0

Contents

01 – THE FOUNDING CONCEPTS OF IDPA.....	- 1 -
02 – SAFETY RULES.....	- 4 -
03 – SHOOTING RULES.....	- 10 -
04 – SCORING RULES	- 18 -
05 – PENALTIES RULES.....	- 26 -
06 – STAGE DESIGN RULES	- 27 -
07 – PERMANENTLY PHYSICALLY DISABLED SHOOTERS RULES	- 32 -
08 – EQUIPMENT RULES.....	- 33 -
09 – CLASSIFICATION RULES	- 52 -
10 – APPEALS PROCESS.....	- 57 -
11 – HEADQUARTERS INFORMATION.....	- 58 -

01 – The Founding Concepts of IDPA

Founded in 1996, the International Defensive Pistol Association (IDPA) is the governing body for IDPA competition, a handgun-centric shooting sport based on simulated self-defense scenarios.

The IDPA competition format was designed to be enjoyable for all shooters of all skill levels, with a premium put on the social interaction and camaraderie of the members. Participation in IDPA matches

requires the use of handguns, holsters and other equipment suitable for concealed carry self-defense. With that in mind, and keeping the shooters' best interests in mind, IDPA's founders established equipment requirements that are based on commonly available firearms and gear, allowing individuals the opportunity to compete with minimal investment.

Today, thanks to the vision of its founders and a commitment to serving the organization's loyal membership, IDPA stands as the fastest growing shooting sport in the United States with over 25000 members from all 50 states, and over 400 affiliated clubs hosting weekly and monthly competitions, and membership representing over 50 nations.

Our main goal is to test the skill and ability of the individual. Equipment that is designed with no application for daily, concealed carry is not permitted in this sport.

1.1 IDPA's Fundamental Principles

The Fundamental Principles are a guide to all members.

1.1.1 Promote safe and proficient use of firearms and equipment suitable for concealed carry self-defense.

1.1.2 Offer a practical shooting sport encouraging competitors to develop skills and fellowship with like-minded shooters.

1.1.3 Provide a level playing field for all competitors that solely tests the skill and ability of each individual, not their equipment.

1.1.4 Provide separate divisions for equipment and classifications for shooters, such that firearms with similar characteristics are grouped together and people with similar skill levels compete against each other.

1.1.5 Provide shooters with practical and realistic courses of fire, and test skills that could be required to survive life-threatening encounters.

1.1.6 Strongly encourage all IDPA members to support our sponsors when making purchases of equipment and accessories. Industry sponsors have been instrumental in IDPA's success at all levels including Club, State, Regional, National, and International levels.

1.1.7 Develop and maintain an infrastructure that will allow IDPA to be responsive to our shooters. While IDPA can never be all things to all people, respectful constructive suggestions from our members, which follow IDPA Fundamental Principles, will always be welcome.

1.2 IDPA's Strict Principles of Safety

As with any firearm competition, safety is the primary and fundamental concern. The Four Rules of Gun Safety are the basis for the IDPA safety rules:

- **All guns are always loaded.**
- **Never let the muzzle cover anything you are not willing to destroy.**
- **Keep your finger off the trigger till your sights are on the target.**
- **Identify your target, and what is behind it.**

1.3 Principles of Shooting IDPA

1.3.1 Equipment Principles

Allowed equipment will meet the following criteria:

- 1.3.1.1** Concealable - all equipment except flashlights will be placed so that, when wearing a concealment garment with your arms extended to your sides and parallel to the ground, it cannot be seen from the front, rear, or sides.
- 1.3.1.2** Practical - Must be practical for all day concealed carry self-defense, and worn in a manner that is appropriate for all day continuous wear.
- 1.3.2** Participation Principles
- 1.3.2.1** Competitors will not attempt to circumvent or compromise any stage by the use of inappropriate devices, equipment, or techniques.
- 1.3.2.2** Competitors will refrain from unsportsmanlike conduct, unfair actions, and the use of illegal equipment.
- 1.3.2.3** The IDPA Rulebook is not intended to be an exhaustive description of all allowed and disallowed equipment and techniques. Shooter equipment and techniques should comply with the basic principles of IDPA and be valid in the context of a sport that is based on self-defense scenarios. A reasonable application of common sense and the IDPA Founding Concepts will be employed in determining whether a particular device, technique, or piece of equipment is permitted under the IDPA rules.
- 1.3.2.4** At its core, IDPA is a self-defense scenario based sport. The props used to create the Course of Fire (CoF) are often incomplete but represent buildings, walls, windows, doorways, etc. The CoF will indicate available shooting positions. The props will be defined in the CoF walk through.
- 1.3.2.5** Individual rehearsals of a CoF, including air gunning, and taking sight pictures, are not permitted within the CoF boundaries.
- 1.3.2.6** Shooting from behind cover is a basic premise of IDPA. Competitors will use all available cover in a CoF.
- 1.3.2.7** IDPA is a shooting sport based on concealed carry. All courses of fire will be shot using a concealment garment unless stipulated otherwise.
- 1.3.2.8** In any single contest, a shooter must use the same firearm on all stages unless the firearm becomes unserviceable.
- 1.3.2.9** Re-shoots are allowed for stage equipment failures or SO interference.
- 1.3.2.10** English is the official language of IDPA and range commands used in all matches regardless of location or nationality of participants, will be in English. The English rulebook prevails.
- 1.3.3** Course of Fire Principles
- 1.3.3.1** One issue critical to the long-term success of this shooting discipline is that problems shooters are asked to solve must reflect self-defense principles. The IDPA founders agreed upon this when they set out to structure IDPA guidelines and principles. IDPA should help promote basic sound gun handling skills and test skills a person would need in a concealed-carry encounter. Requirements such as the use of cover while engaging a target, reloading behind cover, and limiting the number of rounds per string were all based upon that principle.
- 1.3.3.2** A CoF should test a competitor's shooting skills. Allowances will be made for physically challenged or disabled shooters. Match Directors should always attempt to make the CoF accessible for all shooters.
- 1.3.3.3** While we recognize that there are many schools of thought in training for self-defense concealed carry, the primary focus of IDPA is in the continuing development of safe and sound gun handling skills that are universally accepted.
- 1.3.3.4** IDPA rules will be equally enforced for all classifications of IDPA members.

02 – Safety Rules

Colonel Jeff Cooper's Four Basic Rules Of Firearm Safety:

- **All guns are always loaded.**
- **Never let the muzzle cover anything you are not willing to destroy.**
- **Keep your finger off the trigger till your sights are on the target.**
- **Identify your target, and what is behind it.**

Jeff Cooper's Four Basic Rules Of Firearm Safety have appeared in the beginning pages of books, videos, and training courses for more than 30 years. They are time honored and although they are not IDPA safety rules, they serve as the foundation of the safety rules below.

2.1 The Safety Rules below serve as the cornerstone for every IDPA shooter, Safety Officer (SO), Match Director (MD) and Area Coordinator (AC) to follow so that our events are safe and enjoyable to a wide range of participants. They are to be adopted for all IDPA events.

2.2 Unsafe firearm handling will result in immediate Disqualification (DQ) from the IDPA match.

Examples (non-inclusive list):

2.2.1 Endangering any person, including yourself. This includes sweeping one's self or anyone else with a loaded or unloaded firearm. Sweeping is defined as allowing the muzzle of the firearm (loaded or unloaded) to cross or cover any portion of a person.

2.2.1.1 Exception: Some body types combined with some holster types makes it almost impossible to holster a firearm or remove the firearm from the holster without sweeping a portion of the shooter's lower extremities. Thus, a match disqualification is not applicable for sweeping of the shooter's own body below the belt while removing the firearm from the holster or holstering of the firearm, provided that the shooter's trigger finger is clearly outside of the trigger guard. However, once the muzzle of the firearm is clear of the holster on the draw, sweeping any part of the body is a Disqualification.

2.2.2 Pointing muzzle beyond designated "Muzzle Safe Points" if used, or beyond the 180-degree Muzzle Safe Plane if used.

2.2.3 A discharge:

2.2.3.1 In the holster.

2.2.3.2 Striking up range of the shooter.

2.2.3.3 Into the ground downrange closer to the shooter than two (2) yards (1.8 meters), unless engaging a low target that is within two (2) yards (1.8 meters.)

2.2.3.4 Over a berm.

2.2.3.5 During Load And Make Ready, Unload And Show Clear, Reload, or Malfunction Clearance.

2.2.3.6 Before the start signal.

2.2.3.7 While transferring a firearm from one hand to the other.

2.2.4 Handling a firearm except at the firing line. There are only three instances in which a firearm may be removed from the holster:

2.2.4.1 With verbal instruction from a SO.

2.2.4.2 While engaging targets in a CoF under the direct supervision and visual contact of a SO.

2.2.4.3 When in a designated "Safe Area".

2.2.5 Pointing the muzzle over the berm during the "Pull The Trigger" portion of Unload And Show Clear.

2.2.6 Drawing a firearm while facing up range.

2.3 Dropping A Firearm.

2.3.1 Dropping a loaded or unloaded firearm or causing it to fall, during Load And Make Ready, the shooting of a string or stage, reloads or malfunction clearance or during Unload And Show Clear will result in Disqualification from the match. If a shooter drops a firearm the SO will immediately give the command “Stop”. The SO will pick up/recover the dropped firearm and render it safe and unloaded before returning it to the shooter. The shooter will be Disqualified from the IDPA match.

2.3.2 If a competitor drops a loaded or unloaded firearm or causes it to fall within a stage boundary it is a Disqualification from the match.

2.3.3 Dropping an unloaded firearm or causing it to fall while outside of stage boundaries is not within IDPA’s control, and is subject to local Range policy. See rule 6.4 for Stage boundary requirements.

2.4 Ear protection and impact resistant eye protection are required to be used by everyone attending an IDPA shooting event. The responsibility for safe and serviceable ear and eye protection falls completely on the shooter or spectator. IDPA recommends that hearing protection have a minimum 21dB NRR rating and that eye protection have a minimum ANSI Z87.1 impact rating and side shields.

2.5 Pistols used in competition will be serviceable and safe. The responsibility for safe and serviceable equipment falls completely on the shooter. The MD will require a shooter to withdraw any pistol or ammunition observed to be unsafe. In the event that a pistol cannot be loaded or unloaded due to a broken or failed mechanism, the shooter must notify the SO, who will take such action as he/she thinks safest.

2.6 Fingers must be obviously and visibly outside the trigger guard during loading, unloading, drawing, holstering, while moving (unless engaging targets) and during malfunction clearance.

2.6.1 First offense is a Procedural Error penalty. Second Offense is a DQ from the match.

2.6.2 Each “Finger” violation will be clearly noted on the shooter’s score sheet for tracking purposes.

2.7 The normal condition of pistols not in use during a Course of Fire (CoF) is holstered and unloaded, with hammer down or striker forward and magazine removed or cylinder empty. Loaded firearms may only be handled in the safe area when supervised by the MD or a SO. Magazines, speed loaders, and moon clips may be reloaded while off the firing line, but the shooter’s firearm can be loaded or unloaded only under the direction of the SO. (See the rule below regarding Cold Ranges, Hot Bays, and Hot Ranges.)

2.8 All CoFs will be started with the pistol holstered, safeties engaged as required by different divisions, and hands clear of equipment including the concealment garment unless other positions for the pistol are stipulated in the CoF description, (table top, drawer, pack, purse, in the firing hand, etc.)

2.9 Muzzle Safe Points.

2.9.1 If the muzzle of the shooter’s firearm points further up range than a “Muzzle Safe Point” the shooter will be Disqualified from the match. The shooter will be given the command “Stop.” The shooter will stop immediately, place the trigger finger obviously and visibly outside the trigger guard of the firearm, and wait for further instructions from the SO.

2.9.2 There are two types of Muzzle Safe Points used in IDPA. The CoF description will describe which type of muzzle safe point is used or if the two types are used in concert. One or both may be used on a single stage, however if no muzzle safe cones or flags are present on a stage, the default is the 180 rule.

2.9.2.1 A Muzzle Safe Point is a physical and clearly visible marker such as a traffic cone or stake in the ground with a brightly colored flag or marker tape attached.

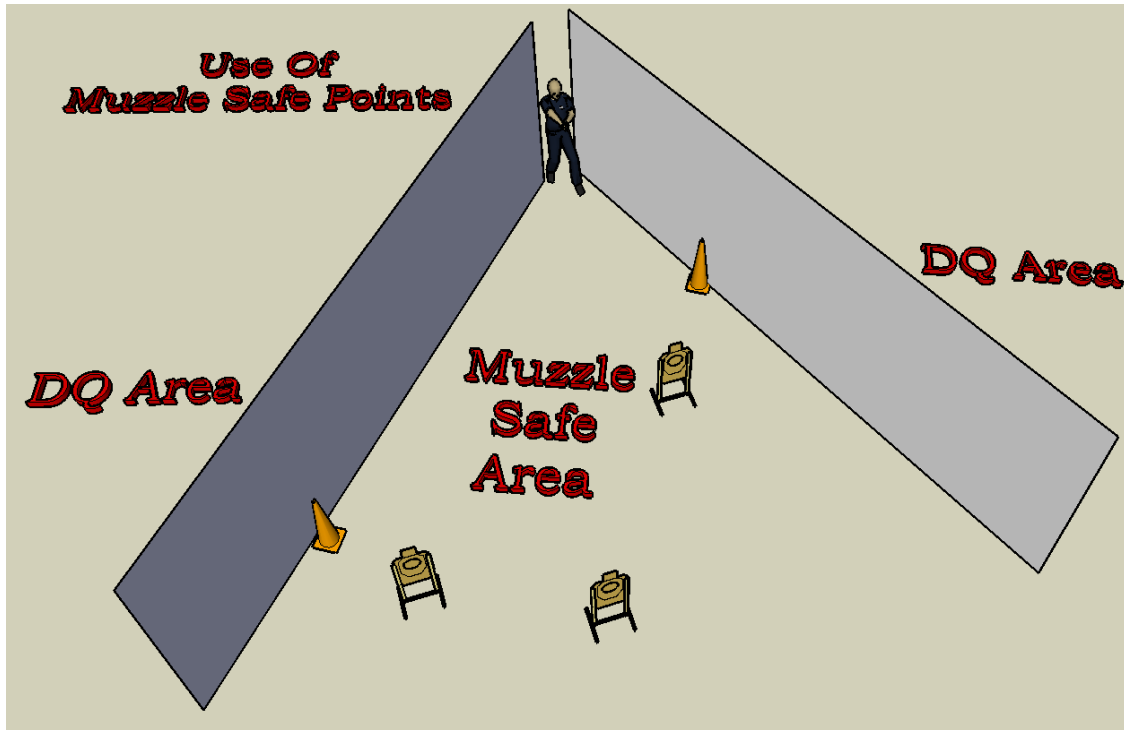

2.9.2.2 The 180-degree plane is an imaginary infinite vertical plane drawn through the centerline of the shooter's body, perpendicular to the centerline of the shooting bay and that moves with the shooter as the shooter moves through the stage.

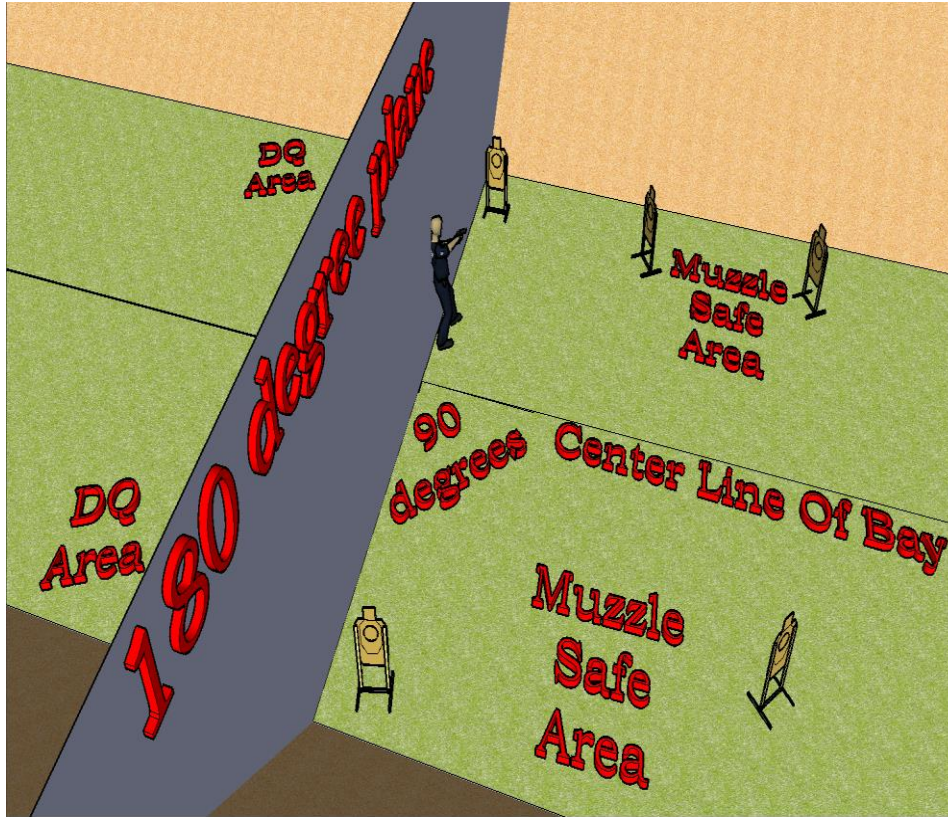

2.9.3 When facing downrange the violation of the 180-degree plane when drawing from a muzzle rearward holster configuration or while holstering a firearm into a muzzle rearward holster configuration is not an infraction.

- 2.10** Safe Areas must be provided for all local and Sanctioned matches, in convenient locations and in numbers adequate to handle the volume of expected shooters. A Safe Area is defined as a designated area where the following rules apply.
- 2.10.1** Each Safe Area is clearly identified by visible signage, including a table with the safe direction and boundaries clearly shown.
 - 2.10.2** Unloaded firearms may be handled at any time. This area is used for bagging or un-bagging a firearm, holstering, drawing, dry firing, or equipment adjustment.
 - 2.10.3** A Safe Area may also be used for inspections, stripping, cleaning, repairs and maintenance of a firearm or related equipment or parts.
 - 2.10.4** In all cases the muzzle of the firearm must be pointed in a safe direction.
 - 2.10.5** Handling of ammunition, loaded ammunition feeding devices, loose rounds, dummy ammunition, snap caps, simunitions, training rounds, or loaded firearms is not permitted.
 - 2.10.6** A Safe Area may also be used, while accompanied by a SO, to render safe a firearm that has locked up and contains a live round or rounds.

2.10.7 Reload practice within the Safe Area is not allowed. An empty magazine may be inserted into a firearm to test functionality or to drop the hammer on a firearm with a magazine disconnect, but reload practice is prohibited.

2.10.8 The violation of any of the cases above will result in Disqualification from the match.

2.11 The question of Hot and Cold ranges at the local club level is subject to individual club policy. This issue is the sole responsibility of local clubs and is beyond IDPA control. Matches sanctioned by IDPA are required to operate under the Cold range rule, but may use Hot Bays if desired.

2.11.1 A Cold range is defined as a range where all shooters' firearms must be unloaded unless under the direct supervision of a SO.

2.11.2 A Cold range with Hot bays is defined as "a range that does not allow loaded firearms in the holster outside of the shooting bays but does allow for loaded firearms in the holster within the shooting bays as directed by and under the supervision of the SOs." Loaded firearms may only be handled while on the firing line when the shooter is given specific Range Commands and is under the direct supervision of a SO.

2.11.2.1 With direct supervision from the SO, and when given specific Range Commands, an entire squad of shooters will line up across the bay, face down range and will "Load And Make Ready" as a group.

2.11.2.2 The perimeter of the bay will be well defined as well as any area designated as a "Safe Area" where handling of ammunition and loaded firearms is not permitted. A procedure for requesting to be unloaded to exit the bay will be established by the CSO and explained to all participants during the stage briefing. If a shooter for any reason needs to leave a Hot Bay, the shooter must contact one of the SOs in that bay to safely unload the firearm before leaving the bay.

2.11.2.3 If a shooter for any reason does not wish to load his firearm with the group, the shooter is not to be penalized.

2.11.2.4 As each shooter finishes the stage he/she will be given the "Unload And Show Clear command, and upon completion, his/her firearm will remain unloaded until the next stage. The shooter may then leave the shooting bay if needed without contacting the SO.

2.11.3 A Hot range is defined as a range where each shooter has the choice to carry a loaded firearm at any time. Loaded or unloaded firearms may only be handled while on the firing line and under the direct supervision of a SO.

2.12 Range Commands

2.12.1 Many of the range commands given to a shooter by the SO are for safety, while the rest are for stage administration.

2.12.2 To allow a shooter to compete anywhere in the world and hear the same commands, the IDPA range commands will only be given in English, the official language of IDPA. These exact range commands must be used and local variations are not allowed.

2.12.3 The complete set of IDPA Range Commands are:

2.12.3.1 Range Is Hot, Eyes and Ears

This is the first command given to each shooter starting the action of shooting a stage. This command signifies the start of the CoF. The shooter will make sure that their eye and hearing protection is in place. It is also notification to anyone in the shooting bay to check that their own eye and hearing protection is properly fitted.

2.12.3.2 Load and Make Ready

When the shooter has proper eye and hearing protection, the SO will issue the Load and Make Ready command. The shooter will prepare the firearm and magazines to match the start position for the stage. Typically this is to load the firearm and holster, but may include non-typical loading or staging of equipment. The shooter will then assume the starting position necessary for the stage. If the shooter's firearm is not to be loaded for the start of a stage the command used will be "Make Ready."

2.12.3.3 Are You Ready?

2.12.3.3.1 After "Load and Make Ready," the SO will ask the shooter "Are You Ready?" If ready, the shooter should respond verbally, or by obvious nodding of the head, but may also choose to stand ready. If there is no response from the shooter in approximately three (3) seconds the shooter is assumed to be ready.

2.12.3.3.2 If the shooter is not ready when this question is asked the shooter must respond "Not Ready". If the shooter continues to not be ready, the shooter must take a step out of the shooting position. When ready the shooter will assume the starting position and the "Are You Ready" question will be asked again.

2.12.3.3.3 The shooter is expected to be ready to proceed approximately fifteen (15) seconds after the "Load And Make Ready" command. If the shooter is ill prepared and needs more than fifteen seconds to get ready, the shooter will be advised that he/she is being given approximately fifteen (15) seconds more to prepare. If the shooter is still not ready after that period, they have earned a Procedural Error penalty and will be moved down in the shooting order.

2.12.4 Standby

This command is given after the shooter is ready. This command will be followed by the start signal within one (1) to four (4) seconds. The shooter may not move or change positions between the "Standby" command and the start signal, unless required to do so by the CoF.

2.12.5 Finger

This command is given when the shooter's finger is not obviously and visibly outside the trigger guard when it should be, as noted above.

2.12.6 Muzzle

This command is given when the muzzle of the shooter's firearm is pointed near a muzzle safe point. The shooter must correct the errant muzzle and continue with the stage. See muzzle safe points above.

2.12.7 Stop

This command is given when something unsafe has happened or is about to happen during a stage, or when something in the stage is not correct. The shooter must immediately stop all movement, place the trigger finger obviously and visibly outside the trigger guard, and await further instruction. Failure to immediately stop and remove the trigger finger from within the trigger guard will result in Disqualification from the match.

2.12.8 Cover

This command is given when a shooter is not properly using cover. Refer to rule 3.5 for specifics of using cover.

2.12.9 If Finished, Unload and Show Clear

This command will be issued when the shooter has apparently finished shooting the stage. If the shooter is finished, all ammunition will be removed from the firearm and a clear chamber/cylinder will be shown to the SO. If the shooter is not finished, the shooter should finish the stage and the command will be repeated.

2.12.10 If Clear, Slide Forward or Close Cylinder

Once the SO has inspected the chamber/cylinder and found it to be clear, this command will be issued and the shooter will comply.

2.12.11 Pull The Trigger

The shooter will point the firearm at a safe berm and pull the trigger to further verify that the chamber is clear. If the firearm fires, the shooter will be Disqualified from the match. This requirement also applies to firearms with a de-cocker or magazine disconnect. For firearms with a magazine disconnect an empty magazine, or dummy magazine must be inserted before the trigger is pulled, and then removed again.

This command is not needed for revolvers.

2.12.12 Holster

The Shooter will safely holster the firearm.

2.12.13 Range Is Clear

This command indicates to the shooter and anyone within the stage boundaries that the range is clear.

This command begins the scoring and resetting of the stage.

2.13 Clubs or Ranges that host IDPA matches may have additional or more restrictive safety requirements.

These safety restrictions will be accommodated by the IDPA MD and staff provided that they do not interfere or conflict with the running of the IDPA Match according to IDPA Safety Rules, or conflict with the Purpose and Principles of IDPA. Any additional restrictions or requirements must be visibly displayed at the range. These additions must be published in all Sanctioned Match announcements where the additional restrictions are in effect.

2.14 The SO will stop a shooter that has started a CoF and is not wearing proper eye or ear protection, and a reshoot will be given to the shooter. If the shooter's eye or hearing protection becomes dislodged during a CoF, the same action applies. If the shooter discovers missing or dislodged eye or hearing protection before the SO and stops, the shooter will also be given a reshoot. A shooter who intentionally loses or dislodges eye and/or ear protection during a CoF will be Disqualified.

2.15 Steel targets must be engaged from ten (10) yards (9.1 meters) or more. If the shooter shoots at a steel target from less than ten yards the shooter will be Disqualified.

2.16 The MD should make every effort that all items used in an IDPA match are in good condition and safe as used. This includes permanent fixtures in the shooting bay, the bays themselves, berms, props, static and moving targets, target holders, doors, walls, barrels, tables, reactive targets, etc.

03 – Shooting Rules

3.1 A concealment garment is required for all stages unless otherwise specified in the stage description. This includes standards and limited stages.

3.1.1 Exception: Police or military personnel using actual duty gear. See definition of duty gear in the Equipment Section.

3.2 Targets must be engaged in tactical priority unless tactical sequence is specified in the stage description. This includes all targets engaged “in the open.”

3.2.1 Tactical Priority: A method of target engagement.

3.2.1.1 For Tactical Priority, targets are engaged by order of threat. Threat is based on the distance of visible threats from the shooter. Targets are considered equal threat when they are two (2) yards (1.8 meters) or less from each other, relative to the shooter.

3.2.1.2 If several targets are visible at the same time, targets are engaged from near-to-far unless they are equal threat.

3.2.1.3 If targets are hidden by a prop, the targets are engaged as they are seen around the edge of the prop (slicing the pie).

3.2.2 Tactical Sequence: A method of target engagement. For Tactical Sequence, all targets must be engaged with one round each before being engaged again. In the case of three (3) targets requiring two (2) rounds each, all targets must be engaged with one round to each target before reengaging the targets with another round in any order (example:1-1-2-1-1). Tactical Sequence may not be used for targets farther than ten (10) yards (9.1 meters) from the shooter. Tactical Sequence may not be combined with Tactical Priority (near-to-far or from cover) on the same targets. Tactical Sequence is only required when it is specified in the stage description.

3.2.2.1 Make up shots during a Tactical Sequence engagement must come after each target has been engaged with at least one round.

3.2.2.2 Failing to use Tactical Sequence when specified incurs one Procedural Error penalty per array of targets and cannot be erased by trying to fix an error in sequence.

3.2.3 A target is considered “Engaged” when:

3.2.3.1 A cardboard target is deemed to have been engaged when the required number of shots for that target has been fired at the target.

3.2.3.2 A reactive target is deemed to have been engaged when a minimum of 1 round is fired at the target, regardless of whether the target reacts. All penalties apply if the shooter does not re-engage the target until the target reacts or if the shooter unsuccessfully challenges the reactive target calibration. See rule 4.24.5 for reactive target calibration details.

3.2.3.3 A cardboard target with a steel activator behind it is considered engaged when the required number of shots are fired at the cardboard target.

3.2.3.3.1 When an activator reveals a target of equal or higher Tactical Priority, the shooter may interrupt the engagement of the cardboard target to engage the target of equal or higher Tactical Priority. The appropriate penalties apply if the shooter subsequently fails to return and complete the engagement of the original target, i.e., fire the required number of rounds at it.

3.2.4 Target engagement penalties shall not apply in the following cases:

3.2.4.1 A shooter may not be penalized for failing to fire the required number of shots at a disappearing target.

3.2.4.2 When engaging a target array of equal priority, the shooter may not be penalized based on the shooter’s order of target engagement, unless tactical sequence is required. The shooter need not complete the engagement of any particular target before proceeding to engage another target in the array. However, at completion of the engagement of the target array, the shooter must have engaged all targets in the array with the required number of shots to avoid receiving a penalty.

3.3 Prior to shooting a stage, a group walkthrough will be given by the SO. During the group walkthrough the SO will verbally indicate to all shooters the vision barriers and points of cover for each target and the criteria that will be used in assessing the shooter's use of cover during the stage. During the group walkthrough, the

shooter will be allowed to view each target from every shooting position. This includes taking a knee or prone position. Other than the group walkthrough, no individual stage walkthroughs are permitted. Individual walkthroughs include walking the path of fire or assuming shooting positions to check cover positions or target engagement, order, etc.

3.3.1 Air gunning and/or sight pictures are not permitted. Air gunning is the act of going through the motions of firing all or portions of the stage with a hand or pointed finger while within the stage boundaries. A sight picture is the act of drawing a loaded or unloaded firearm and aiming it downrange before the start signal to begin a stage.

3.3.2 Stage boundaries mark the region wherein the shooter becomes subject to the rules of air gunning, sight picture and an individual walkthrough.

3.4 IDPA Reloads

There are only two (2) IDPA approved reloads:

3.4.1 Slide Lock/Empty Cylinder Reload (also known as an Emergency Reload)

Slide Lock/ Empty Cylinder Reload – recharge the firearm when it is empty and/or out of live ammo.

3.4.2 Loaded Cylinder/Loaded Chamber Reload (also known as a Tactical Reload or Reload with Retention)

Loaded Cylinder/Loaded Chamber Reload – recharge the firearm when it is partially loaded while retaining any live ammunition and/or an ammunition feeding device from the firearm even if the ammunition feeding device is empty.

3.4.3 The shooter initiates a reload by performing any one of the following actions:

3.4.3.1 Withdrawing a magazine, speed loader/moon clip from a carrier, pocket or waistband.

3.4.3.2 Activating the magazine release on a semi-auto pistol (as evidenced by the magazine falling from the firearm)

3.4.3.3 Opening the cylinder of a revolver.

3.4.4 A firearm is deemed reloaded when the magazine is fully seated and the slide is fully forward or the revolver cylinder is closed and the firearm contains at least one unfired cartridge in the chamber, magazine, or cylinder. If the shooter “drops” or “racks” the slide prior to leaving a “position of cover,” and the slide fails to go fully forward into battery, this shall be considered a malfunction. No penalty shall be assessed.

3.4.5 A firearm is deemed empty when there is no live ammunition in the chamber and magazine for semi-autos and no live ammunition in the cylinder for revolvers.

3.5 Cover

When cover is available it must be used when engaging targets, unless the shooter is “in the open” and must engage targets “in the open.” Shooters may not cross or enter any openings (doorways, open spaces, windows, etc.) without first engaging targets visible from those locations.

3.5.1 Stages will have one or more of the following cover situations:

3.5.1.1 There is no cover anywhere in the stage.

3.5.1.2 The shooter starts “in the open” with targets to be engaged “in the open.” Up to 6 shots may be required “in the open” while the shooter is stationary or while moving to the next shooting position.

3.5.1.3 The shooter engages targets from cover.

3.5.1.4 When moving between two positions of cover the shooter “discovers” a target during movement either behind a vision barrier or after a target is activated and “appears.” Up to 6 shots may be required on “discovered” or “surprise” targets “in the open” and must be engaged on the move.

3.5.2 The cover line extends back from the center of the target body -0 zone to the point of the physical barrier up range to the stage boundary. If the entire body -0 zone is not visible to the shooter, the cover line extends back from the center of the visible -0 zone.

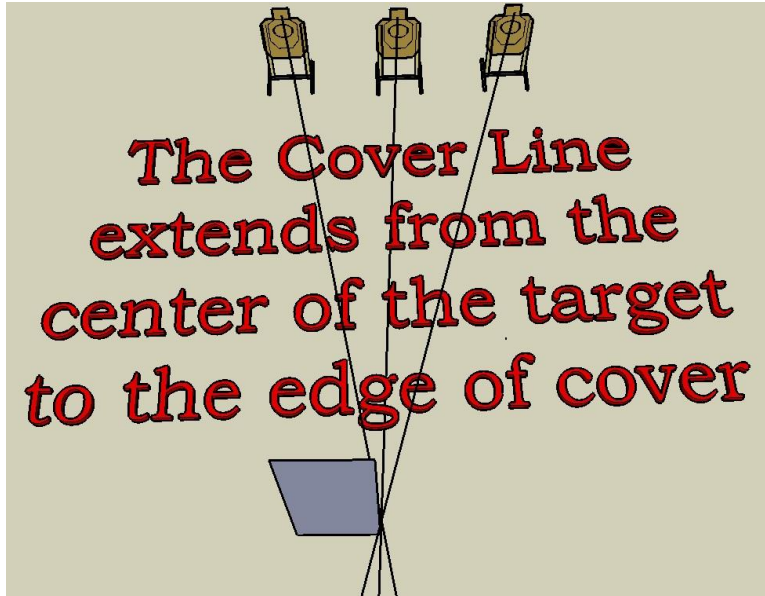

3.5.3 For vertical cover when shooting, reloading and clearing a malfunction, at least 50% of the shooter's upper body, as well as 100% of the shooters legs and feet must be behind cover. Low cover is the same as vertical cover and additionally requires at least one knee touch the ground. For a combination of low and vertical cover, e.g. a barrel, the shooter's legs and feet must be behind cover and at least 50% of the shooter's upper body must be behind cover; however, simultaneous partial exposure of the shooter's upper body above and around the cover is permitted as long as the cover requirements above are met.

3.5.4 At no time should a shooter stand directly in a window or port to engage targets. Shooters must slice the pie around the edge of the window or port. The portion of the shooter's body above and below the window or port is of no concern when with using cover around the edge of the window or port. The opposite sides of a single window or port shall be considered separate positions of cover.

3.5.5 If the shooter fires a shot out of cover, prior to being given a cover warning, then the following applies:

3.5.5.1 A PE is assessed.

3.5.5.2 The SO should not call "Cover" after the shot has been fired.

3.5.5.3 Rationale: The shooter has already earned the PE since the shooter broke the shot before the SO could provide the courtesy cover warning. Once the PE has been earned, if the SO subsequently calls cover, then the shooter is in effect being penalized twice, once for shooting out of cover, and then by taking the time to move back into cover. However, an inadvertent or delayed cover warning by the SO, subsequent to the shot firing, does NOT invalidate the PE assessment nor does it necessitate a re-shoot.

3.5.5.4 If the shooter breaks cover, and moves back behind cover before firing a shot, then no PE is assessed.

3.5.6 If the shooter is given a "Cover" call and still fires a shot out of cover, a PE is assessed.

3.6 Cover And Reloads

3.6.1 All reloads must be performed behind cover; however, if a shooter runs the firearm empty while engaging targets "in the open," as required or allowed by the CoF description, the shooter may initiate an

Emergency Reload while advancing to the next shooting position specified in the CoF. The shooter may not engage any more “in the open” targets until after reaching the next shooting position.

3.6.2 If the shooter did not completely engage all of the "in the open" targets before running the firearm empty, no Procedural Error penalty shall be assessed for a failure to engage targets per the CoF description.

3.6.2.1 If the shooter reloads and continues to engage targets while moving to the next shooting position, a Procedural Error penalty will be assessed for each shot fired.

3.6.2.2 If the shooter can safely complete the engagement of any remaining "in the open" targets from the next shooting position, the shooter may do so without incurring additional target scoring or Procedural Error penalties. If the shooter cannot safely complete engagement of the remaining targets from the next shooting position, the shooter shall be assessed points down and FTN penalties, as applicable, for any unengaged or partially engaged "in the open" targets.

3.6.2.3 If no "next shooting position" is specified in the CoF, e.g., the "on the move" targets are the final targets to be engaged in the CoF, no reload is allowed and the shooter shall be assessed points down and FTN penalties, as applicable, for any unengaged "on the move" targets.

3.6.3 A shooter can reload behind cover while stationary or moving along a single contiguous piece of cover as long as the shooter is not visible to any un-engaged targets while reloading.

3.6.4 A shooter may not leave cover, cross or enter any openings with an empty firearm or while reloading, even if visible targets have been engaged or there are no visible targets.

3.6.4.1 If a shooter starts to cross an opening with an empty firearm, realizes the mistake, moves back behind cover and completes a reload before leaving cover then no penalty is assessed.

3.6.4.2 Hallways, corridors and rooms are a unique situation. When a contiguous wall from the last shooting position and one or more other wall(s) form a hallway or room, and the combination of walls provide cover for the shooter on two sides or more, the shooter can do any kind of approved IDPA reload while moving through a hallway or room after all visible targets within have been engaged.

3.6.5 Cover and Reload Examples

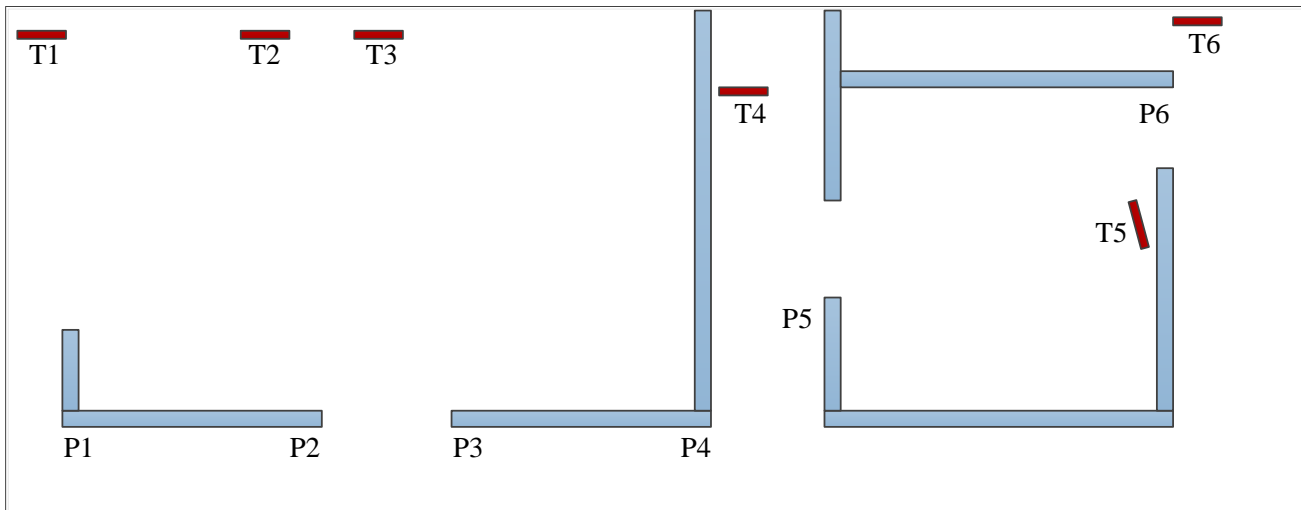

3.6.5.1 Any kind of stationary or moving approved IDPA reload may be done anywhere between P1 and P2 inclusively or between P3 and P4 inclusively.

3.6.5.2 No reload of any kind can be done between P2 and P3.

3.6.5.3 Any kind of stationary or moving IDPA approved reload may be done anywhere between P4 and P5 after T4 is engaged. And any kind of stationary or moving IDPA approved reload may be done anywhere between P5 and P6 after T5 is engaged.

- 3.6.5.5** If a shooter engages T3 around cover at P2, then engages T2 around cover at P2 and then notices that T3 needs a make-up shot, the shooter may re-engage T3 from the same exact position used to shoot T2 without incurring a cover penalty.
- 3.6.6.6** If a shooter engages T4 using cover and then upon getting closer to T4 notices that a make-up shot is needed, the shooter make take the make-up shot. These make-up shots can be taken from cover or in the open while moving, if it is safe to do so.
- 3.6.6** If the shooter has ammo remaining, not reloading to fire the last one or more rounds in a stage is an automatic FTDR penalty.
- 3.7** At no time is it permissible to fire while holding a magazine, speed loader/moon clip, or loose ammunition. Holding shall be defined as touching, grasping or supporting a magazine, speed loader/moon clip or loose ammunition.
- 3.8** A penalty will be assessed any time a loaded ammunition-feeding device (magazine, speed loader, or full moon clip) is dislodged and falls out of an ammunition carrier during a course of fire. This includes the case where an ammunition-feeding device is inside an ammunition carrier and they are both dislodged.
- 3.8.1** Ammunition carrier: Any location a shooter chooses to store a loaded or partially loaded ammunition-feeding device.
- 3.8.2** Dropping a loaded magazine or speed loader/moon clip involved in a reload during a reload does not incur a penalty as long as the shooter retrieves and properly stows the loaded magazine or speed loader/moon clip prior to the firing of the last shot in the string of fire.
- 3.8.3** Malfunction Clearing Exception: When clearing a malfunction, the magazine or speed loader/moon clip and /or ammunition that may have caused the malfunction does not need to be retained by the shooter and will incur no penalty if dropped.
- 3.9** A shooter may not remove a magazine/loading device after the start signal and stage it for use later in the stage; however, the stage description may specify staging magazines/loading devices prior to the start signal for all shooters as part of the CoF.
- 3.10** Firearms must start from the mechanical condition of readiness appropriate to their design and shooter's division.
- 3.11** Firearms and magazines must always be loaded to the shooter's division capacity, unless otherwise specified by the stage description.
- 3.11.1** Firearms and magazines manufactured such that they cannot be loaded to the division capacity may still be used as long as they are loaded to their maximum capacity and meet all other criteria for that division. See section 8.1.2. for complete magazine loading details.
- 3.12** Once the shooter has assumed the "ready position" and the "Standby" command has been given, the shooter's physical position may not be changed prior to the start signal, with the exception of head movements, provided such movements do not contradict the ready position requirements specified in the stage description.

3.13 Unless specified otherwise in the stage description, the default ready position is defined as the shooter standing erect with body relaxed and hands resting naturally at sides.

3.14 Start Position Errors

3.14.1 If an SO determines that a shooter was allowed to start in an incorrect start position (at the time the “Standby” command was given,) a reshoot is required and no penalty is assessed. Note: This rule does not apply to equipment start condition (loaded with correct number of rounds, etc.)

3.14.2 When a stage is started in an incorrect start position and the shooter notices but the SO does not notice, the shooter must request a reshoot immediately following the holster command and prior to the scoring of targets. If not requested during this period, no reshoot will be allowed.

3.15 No shooter can reshoot a stage or string for firearm or “mental” malfunctions. Reshoots are required for stage equipment malfunctions. If an SO feels he has interfered with a shooter, he will offer a reshoot to the shooter immediately following the holster command and prior to the scoring of targets, as determined by the SO. If a shooter feels he has been interfered with by an SO, the shooter must request a reshoot immediately following the holster command and prior to the scoring of targets. The MD will determine if a reshoot request is granted.

3.16 Firearm Hand Usage Restrictions – Stage Description

3.16.1 Strong/Dominant Hand Only: A denotation in a stage description indicating that only the strong or dominant hand (the shooter’s primary firing hand, located on the same side of the body as the holster) can be used to control the firearm when a shot is fired. The weak (support) hand or arm must not touch the firearm or any location on the shooter’s strong (dominant) arm or hand when firing. For safety reasons, both hands may be used when clearing a malfunction or reloading.

3.16.2 Weak/Support Hand Only: A denotation in a stage description indicating that only the weak or non-dominant hand, i.e., the shooter’s support hand, located on the opposite side of the body from the holster, can be used to control the firearm when a shot is fired. The strong (dominant) hand or arm must not touch the firearm or any location on the shooter’s weak (support) arm or hand when firing. For safety reasons, both hands may be used when clearing a malfunction or reloading.

3.16.3 Freestyle: A denotation in a stage description that the shooter may use either hand or both hands to control the firearm while firing, at the shooter’s discretion.

3.16.4 No weak hand drawing from the holster is allowed.

3.17 Flashlight Usage Rules

3.17.1 If a shooter elects or is required to use a flashlight on a stage, the default starting position for the flashlight is in the shooter’s support hand with the light off, unless otherwise dictated by the stage description. The stage description may not force the shooter to start with the flashlight stowed on his or her body.

3.17.2 Once the stage begins the flashlight may be left on during the entire stage at the shooter’s discretion.

3.17.3 The flashlight must be retained by the shooter throughout the course of fire, and held in the shooter’s support hand while shooting.

3.17.4 A dropped flashlight does not incur a penalty as long as the shooter retrieves the flashlight prior to firing the next shot in the string of fire. Note: if a shooter drops a flashlight, the SO may, at their

discretion, illuminate the area for safety reasons until the shooter retrieves the flashlight. This will not be deemed SO interference.

3.17.5 The shooter's flashlight may be used to recharge night sights any time after the start signal, but not prior.

3.18 Range Commands to be used in IDPA shall be:

3.18.1 Range Is Hot – Eyes and Ears

3.18.2 Load and Make Ready (or Make Ready for unloaded gun starts.)

3.18.3 Are You Ready? (If no response, shooter is assumed ready.)

3.18.4 Standby

3.18.5 Finger

3.18.6 Muzzle

3.18.7 Stop

3.18.8 Cover

3.18.9 If Finished, Unload and Show Clear

3.18.10 If Clear, Slide Forward or Cylinder Closed

3.18.11 Pull the Trigger (Not required for revolvers.)

3.18.12 Holster

3.18.13 Range is Clear

03.19 IDPA Shooter Responsibilities and Code of Conduct

By shooting IDPA Matches, I agree to the following:

3.19.1 I understand that it is a privilege, and not a right, to be an IDPA Shooter.

3.19.2 I will follow all of the safety rules of IDPA and the host range. The safety of the shooters, match officials, and bystanders shall always be my primary objective.

3.19.3 Prior to and during a match, I will refrain from the use of alcohol, substances, or medications that may negatively impact my ability to shoot safely.

3.19.4 I will maintain a current IDPA membership after my first match.

3.19.5 I will maintain an accurate Classification by shooting a Classifier at least every 12 months. Unless a Master or Distinguished Master Classification is attained, a Match Performance Promotion has occurred in the last 12 months, or a Sanctioned Match has been completed in the last 12 months without DNF or DQ. See rule 9.2 for more details.

3.19.6 I recognize that it is my responsibility to maintain a working knowledge of the current IDPA rulebook.

3.19.7 I will adhere to the IDPA purpose and principles and will not willfully break any IDPA rule.

3.19.8 I will listen carefully and refrain from talking during shooters' briefings and stage briefings.

3.19.9 I understand it is my responsibility to be ready to shoot when called to the line.

3.19.10 I understand it is my duty to help reset stages between shooters unless I am the current shooter, the on-deck shooter or have just finished shooting, unless instructed otherwise by an SO.

3.19.11 I will not communicate with others in a threatening, harassing, or abusive manner.

3.19.12 It is my responsibility to check my match scores within the verification period to see that they are correct.

3.19.13 It is my responsibility to check my Classifications in the on-line database to verify that they are correct and to initiate corrective action if they are not correct.

3.19.14 If I have a question or an issue, my first contact is with the CSO at the match, then the MD, then the AC, then IDPA HQ.

3.19.15 I understand that violations of these responsibilities and code of conduct will result in my Disqualification from a match, and may result in the revocation of my IDPA membership.

04 – Scoring Rules

4.0.1 The scoring system in IDPA is designed to reward a balance of accuracy with speed. IDPA scoring converts everything to a time score and the lowest time wins. The scoring system is also designed to be very simple to understand and use.

4.0.2 The main thing to remember when scoring in IDPA is that everything is based on time, the raw time it takes to shoot a stage and the accuracy of the hits on the targets, where inaccuracy adds time to the score. Part of the simplicity of IDPA scoring comes from not using the total points of a target, and instead using points down on each target. Each point down adds a ½ second to the time for the stage.

4.1 Unlimited Scoring

4.1.1 Unlimited Scoring allows the shooter to shoot at each target as much as deemed necessary, as long as this does not violate other IDPA rules. The best hits on a target are used for score. This gives the shooter the option to make up misses or hits that they are not satisfied with, to improve their score. When the shooter does not fire enough rounds at a target, the unfired rounds are counted as misses and a Procedural Error penalty is assessed for not following the CoF description.

4.1.2 Each Course of Fire description will specify how many hits are required on each target. For example if three (3) hits are required on each target, then the best three hits will be scored, if there are more than three hits on the target.

4.1.3 To tally an Unlimited score, take the time it took to complete the strings of fire (raw time from the shot timer) and total up the points down from each target. The raw time is added to the total points down for the stage multiplied by 0.5 seconds, and then added to any other penalties if applicable.

4.2 Limited Scoring

4.2.1 Same as Unlimited Scoring described above except the number of shots to fire in a string is limited to exactly the number specified in the CoF description. Additionally, the Failure To Neutralize penalty does not apply in Limited Scoring stages.

4.2.2 Any extra shots in a string of fire will incur one Procedural Error penalty per string and for each extra shot one (1) of the best scoring hits will be taped over before the score is calculated. When the shooter does not fire enough rounds at a target, the unfired rounds are counted as misses, a Procedural Error penalty is assessed for not following the CoF description, and other penalties may apply.

4.3 Incomplete Stage

4.3.1 If a shooter has started a stage but cannot finish the stage due to a broken firearm, squib, or personal injury the score will be determined by whichever of the following methods results in the best score.

4.3.2 If the SO stopped the shooter for a perceived squib, and it turns out not to be a squib the shooter will be given a reshoot. If the SO stopped the shooter for a perceived squib, and it is a squib, the score will be determined by whichever of the following methods results in the best score. If the shooter stopped on his/her own for a perceived squib, then squib or not, the score will be determined by whichever of the

following methods results in the best score. A penalty for not shooting the required number of rounds for the stage does not apply to either method.

4.3.2.1 Method A: All required shots that were not fired will be scored for points down and failure to neutralize if applicable. These points down, converted to time will be added to the total time, points down and penalties if applicable, up to the last shot taken in the stage.

4.3.2.2 Method B: The minimum number of shots required for the stage is multiplied by three (3) seconds for a stage score.

4.4 Did Not Finish Match (DNF)

4.4.1 A shooter that chooses not to shoot a stage will be given a DNF for that stage but may continue to shoot other stages for no total match score.

4.4.2 A shooter that chooses not to shoot a stage must notify the SO before the Load and Make Ready command.

4.4.3 If a shooter's ammunition fails to make the minimum power factor, they can continue to shoot the match for no score, but may not contest the calibration of any targets. Their score will be "DNF" on all stages and they will not be eligible for any awards.

4.5 Always award any reasonable question on scoring to the shooter.

4.5.1 If the Safety Officer has to look at a target very closely for an extended time to determine if a shot has touched a better scoring line, the better value will be used. IDPA scoring will not use scoring plugs or overlays. When a Safety Officer has a reasonable doubt on a scoring call, the SO will award the better score to the shooter. This also applies to possible doubles. However, this does not automatically mean that every miss is a double.

4.5.2 Video of shooters cannot be used to determine the shooter's score or appeal an SO's decision.

4.6 Typically, bullet holes leave a grease ring, and it is used to determine the outside diameter of the hole for scoring. However bullets passing through another target, clothing placed on the target, soft cover, etc., do not have to have a grease ring to be scored as a hit.

4.7 A radial tear is not used to give a shooter a better score. If the actual area of the bullet hole does not reach the next better scoring ring, the shooter gets the lower score even if the tear reaches the next higher scoring ring.

4.8 Bullet Holes

4.8.1 Oval or elongated bullet holes made in a target that exceed two bullet diameters do not count for score. This situation normally occurs for moving targets fired upon at extreme angles or targets where the shooter is moving.

4.8.2 The elongated bullet hole rule does not include keyhole bullet holes (a keyhole bullet hole is created by a bullet which tumbles out of the firearm barrel and appears to have gone through the target sideways,) which count for score if they were made without interference from another object.

4.8.3 Odd shaped holes made by bullets ricocheting off of the bay floor, props, steel, etc., are not scored. Only holes made by whole bullets, not fragments, are scored.

4.8.4 Only bullet holes entering the front of the target will be scored.

4.9 Hard Cover / Soft Cover Scoring Implications

4.9.1 Stage props are commonly used to represent hard cover or impenetrable objects such as walls, cars, barricades, and furniture such as desks and file cabinets. Truly impenetrable objects may also be used as hard cover in a stage.

4.9.2 IDPA requires that clubs/course designers standardize on Black for hard cover simulation. IDPA recommends that clubs/course designers standardize on White for “Soft” cover simulation, or use props such as windows, curtains, shrubs, etc.

4.9.3 Any shot that puts a full diameter hole in an object designated as hard cover and continues on to penetrate a target will be considered to have missed the target, (whether the target is a threat or a non-threat.) If the SO cannot tell which shot through hard cover hit a threat target, remove the best hit from the target for each full diameter hole in the hard cover.

4.9.4 Shots that penetrate soft cover will be scored as hits, (whether the target is a threat or a non-threat.)

4.9.5 Threat and non-threat indicators painted or marked in the color black are not hard cover.

4.9.6 Threat indicators made of impenetrable material are considered hard cover.

4.10 Targets may be covered with clothing as desired. This is typically done with T-shirts, cut into a front half and a back half and one half is clipped or stapled onto the target sticks holding the target. Only a single layer of lightweight clothing material may be between the shooter and a score-able target.

4.11 Threat and Non-Threat Target Designation

4.11.1 Non-threat targets must be designated by displaying a pair of normal sized open hands of contrasting color, at least one of which must be visible from all shooting positions where the target may be shot.

4.11.2 Threat targets may be designated by displaying a normal sized threat indicator, like a firearm or knife that is visible from all shooting positions where the target may be shot. Threat target designation is not mandatory, but is highly recommended. In no case should a threat indicator and a hand be positioned on the same target. Threats indicators cannot look similar to non-threat hands. Targets must be easily identified as threat or non-threat.

4.11.3 Threats indicators of different kinds all have equal threat value and do not change target engagement priority. That is, a knife is equal in threat to a shotgun, rifle, or other firearms.

4.11.4 Threat and non-threat indicators may be painted or marked on the targets or covering clothing, or may be clipped or stapled to the target.



4.12 Shoot Through

On a shoot through of a non-threat target that also strikes a threat target, the shooter will get the penalty for the non-threat target hit and will get credit for the scored hit on the threat target. The reverse also applies when a round on a threat target penetrates a non-threat or threat behind it. All target shoot throughs count.

4.13 Failure To Neutralize

A Failure To Neutralize (FTN) is defined as any scored target without a down zero or down one hit, no matter how many hits are made. A reactive target (steel, reactive polymer, etc.) must react properly to a hit or it is scored as a FTN in addition to applicable points down. A Failure To Neutralize a target adds 5 seconds to the shooter's score, per infraction. The FTN is not applicable to Limited Scoring or disappearing targets. See rule 6.17 on disappearing targets.

4.14 Hit On Non-Threat

A hit on Non-Threat (HNT) is defined as a hit in any scoring zone of a target that is designated a non-threat. A reactive non-threat target (steel, reactive polymer, etc.) must react properly to a hit to be scored as a HNT. Each hit on a Non-Threat adds 5 seconds to the shooter's score.

4.15 Target Scoring Zones

4.15.1 Head is defined as that part of the cardboard IDPA silhouette above the neckline. Shots designated for the "head" or "head only" must hit the part of the cardboard silhouette within the scoring area above the neckline, or they are counted as a miss, even if they hit another part of the silhouette.

4.15.2 Body is defined as that part of the cardboard IDPA silhouette below the neckline. Shots designated for the "body" or "body only" must hit the part of the cardboard silhouette within the scoring area below the neckline, or they are counted as a miss, even if they hit another part of the silhouette.

4.15.3 Target, sometimes referred to by number like T1, T2, etc., is defined as the sum of the Body plus the Head, the whole silhouette. Shots designated for a "target" can hit within the scoring area in the body or the head for score.

4.15.4 A single IDPA cardboard target will not be divided into two or more scoring areas that are scored separately. For example, a line of black tape may not be used to turn a single target into two targets, with separate scoring and FTNs being possible on both areas.

4.16 Signing The Score Sheet

4.16.1 For Sanctioned Matches the Scorekeeper must sign or initial the paper score sheet after each shooter's raw time, points down and penalties are determined and recorded. For Sanctioned Matches each shooter must sign or initial their paper score sheet. Signing or initialing the paper score sheet gives the shooter the chance to review and understand the score. Local matches can require signatures, initials, or acknowledgement of electronic scores at their discretion.

4.16.2 Whether the shooter signs or initials the score sheet or acknowledges the electronic score or not, it does not freeze the score. The score may be edited and updated up to the time when official scores are posted and the protest period begins.

4.16.3 After the score sheet leaves the control of the original Scorekeeper, only the MD can make changes. Other SOs or other staff cannot change the score sheet or the score. If that needs to be done, the Match

Director will be called to determine if changes are appropriate and make those changes. A reasonable attempt to notify the shooter of the changes will be made and documented.

4.16.4 The shooter, SO, or Scorekeeper cannot be given any type of penalty for the state of the score sheet, even if the shooter does not sign the score sheet, the score sheet is incomplete, is illegible, has the wrong sticker attached, is inaccurate, etc.

4.17 Allowable Targets

An inclusive list of allowed targets for local and Sanctioned Matches:

4.17.1 Official IDPA cardboard targets may be stationary or moving. These targets will be scored as marked, as down zero (-0), down one (-1), down three (-3), and a miss is down five (-5).

All cardboard targets used in IDPA local and Sanctioned Matches must be Official IDPA cardboard targets.

Official IDPA cardboard targets are available directly from IDPA headquarters and from licensed IDPA target manufacturers in each geographical area. Contact IDPA HQ, see listing in the Tactical Journal, or use the website at www.IDPA.com.

4.17.2 Official IDPA cardboard targets with the round down zero area cut out for scoring ease may be used only as a stationary target. The target may be shot starting within 3 yards (2.7 meters) or less and shot while stationary or moving away from the target. These targets will be scored as marked, as down zero (-0), down one (-1), down three (-3), and a miss is down five (-5).

4.17.3 Stationary full sized and miniature Popper and Pepper Popper reactive targets with a minimum height of twenty-four (24) inches (61 centimeters) and a minimum width of eight (8) inches (20.3 centimeters). These targets are scored as down zero (-0) if they fall. If the target is left standing it is scored as down five (-5) plus FTN if applicable.

4.17.4 Stationary steel reactive vertical plates representing target legs that present a target at least three (3) inches (7.6 centimeters) wide and at least fifteen (15) inches (38.1 centimeters) tall are allowed. These targets are scored as down zero (-0) if they fall. If the target is left standing it is scored as down five (-5) plus FTN if applicable. The calibration zone for this target is the upper ½ of the target leg.

4.17.5 Stationary IDPA Reactive Target (RRT). An IDPA cardboard target covered with a t-shirt or other clothing is held in front of down zero sized steel plates that are aligned with the down zero zones on the cardboard target. One of the steel plates must be hit to knock down the target. These targets are scored as down zero (-0) if they fall. If the target is left standing it is scored as down five (-5) plus FTN if applicable. The cardboard holding the clothing is not scored. This target type is not counted in the steel paper ratio. The round down zero steel plate of the target is the calibration zone.

4.17.6 Stationary Popper Behind Paper may be used to activate other targets. An allowed Popper or Pepper Popper as described above situated behind an official IDPA cardboard target such that a down zero hit on the cardboard target will knock down the Popper. The Popper must be visible above or below the cardboard target from all shooting positions from which the target may be shot. The calibration zone on this setup is the round down zero area on the cardboard target. It is part of the shooting problem for the shooter to solve to ensure the Popper behind is activated when the cardboard is shot. The cardboard target is scored normally. The Popper is used only as an activator and is not scored, nor does it count in the paper to steel ratio calculation.

4.17.7 Other targets allowed if and only if they represent something pertinent and appropriate to the stage scenario.

- 4.17.7.1 Stationary or moving Official IDPA cardboard targets with a small portion of the scoring area cut away such as removing the -3 scoring area, leaving a non-scoring $\frac{3}{8}$ " (9.5 mm) perimeter remaining.
- 4.17.7.2 Stationary or moving Official IDPA cardboard targets with black hard cover painted on them.
- 4.17.7.3 Official IDPA cardboard targets may have their scoring area reduced by painting the non-scoring area with a high contrast color that is not black.
- 4.17.7.4 Stationary 6" (152.4 mm) or larger diameter round reactive steel or reactive polymer plates.
- 4.17.7.5 Stationary 6" (152.4 mm) or larger square reactive steel or reactive polymer plates.
- 4.17.7.6 Other stationary steel reactive plates with 28.3 square inches (182.6 square centimeters) or more surface area where the smallest dimension presented to the shooter must equal or exceed three (3) inches (76.2mm.) The MD will define the calibration zone for these targets.
- 4.17.7.7 Stationary Clay pigeon targets (examples: simulate a door lock, or an ocular area, etc.) Clay pigeon targets are not subject to calibration.
- 4.17.7.8 New targets will be evaluated annually.

Official IDPA Target

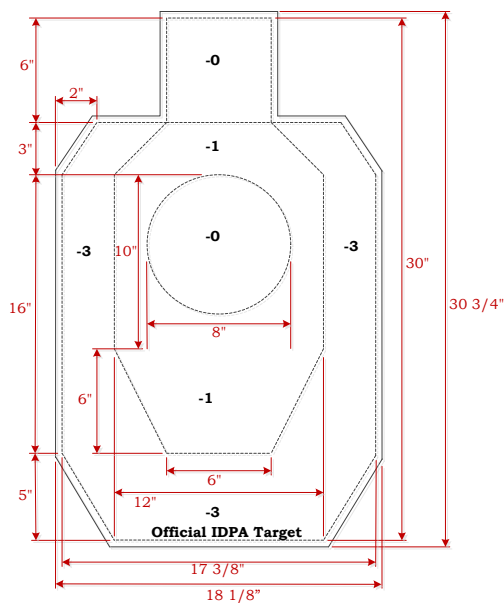

4 - 5 perforations per inch

Official IDPA Alternate Target
Allowed only where the normal IDPA target is outlawed.

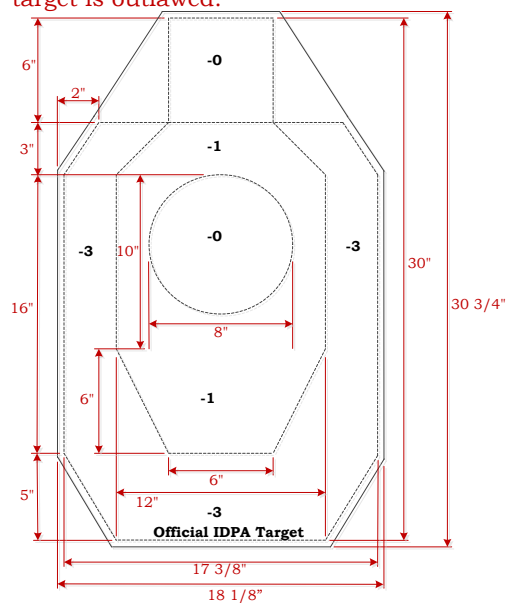

4 - 5 perforations per inch

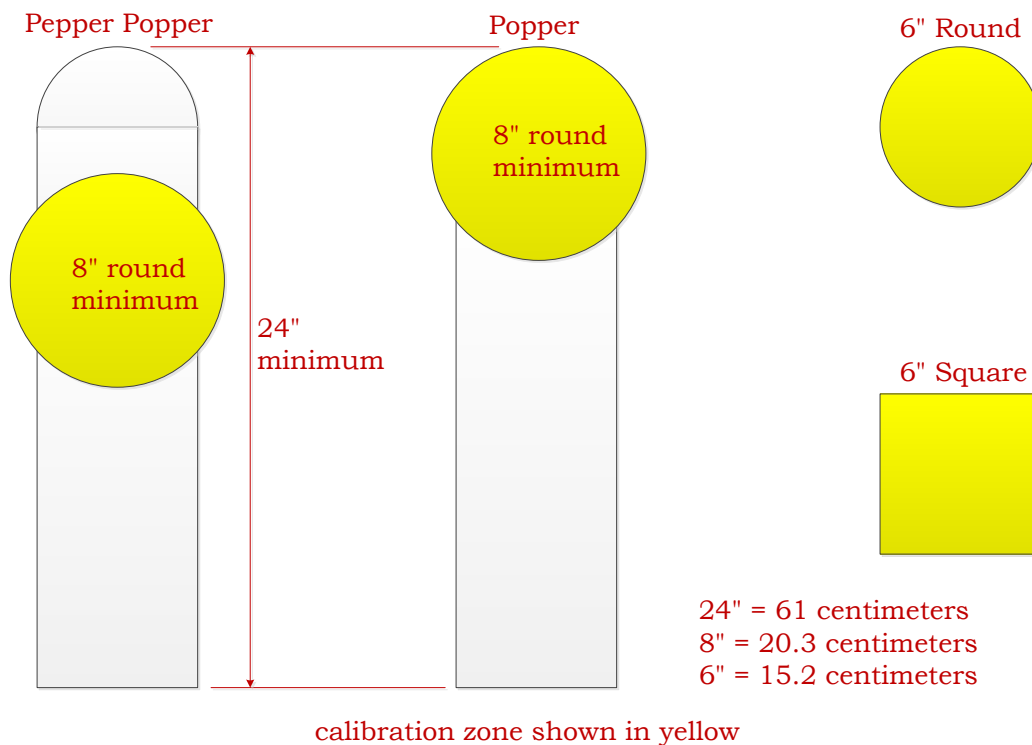

4.18 Reactive targets are defined as those that fall or move or change shape when hit. Reactive targets are scored as down zero (-0) if they fall or are broken in the case of clay pigeons. If the target is left standing it is scored as down five (-5) plus FTN if applicable. Reactive targets must be constrained so that they cannot turn or spin when hit.

4.19 Non-inclusive list of dis-allowed targets:

Bowling Pins, Texas Star, Plate Rack, Polish Plate Rack, Dueling Tree, Slider Triple Dropper, Golf Balls, Balloons, Eggs, Cowboy Poppers, IDPA Practice Target, Animal Shaped Steel Targets, Tombstone Popper, Coffin Popper, and other similar targets including other novelty targets, etc.

4.20 Only rounds fired by the competitor may be used for scoring in a stage.

4.20.1 That is, things like throwing of knives, knocking over poppers by hand, punching a sparing dummy, etc., will not be scored, but may be required on the clock.

4.20.2 Any round required to be fired at a target by the competitor must be scored. That is, if six shots are required to be fired at a target, six shots will be scored.

4.21 All results from local and Sanctioned Matches must include the IDPA membership number for each shooter. Per the Shooters Responsibilities and Code of Conduct, a shooter must become a member of IDPA after their first match. For those shooters temporarily without a current IDPA membership, an “XXX” may be displayed on the Match Results instead of the IDPA number.

4.22 Touching Targets

4.22.1 Shooters or their delegate will not touch or interfere with any target that has just been shot and has not yet been scored by the SO or Scorekeeper unless specifically authorized by the SO or Scorekeeper. If

a target is interfered with by the shooter or designee before it is scored, that target will be scored as all misses. Additionally, the original hits on the target will be used to determine if an FTN score also applies. Example: a target requiring two shots, with two down three hits that is touched by the shooter will be scored as two misses and a FTN.

4.22.2 If a target is taped before it is scored, the SO will try to give the correct score if it can be discerned. Otherwise, the shooter will be given a reshoot.

4.22.3 The SO or Scorekeeper will not touch a target on the front or back of the target near the bullet holes before or during the scoring process.

4.22.4 If a target is scored and taped before the shooter or designee can see the target, the score stands.

4.22.5 If a target is not taped between shooters, the SO will try to give the correct score if it can be discerned. Otherwise, the shooter will be given a reshoot.

4.23 Targets where a scoring dispute is ongoing will be pulled from the stage and held for arbitration by the Chief Safety Officer or Match Director.

4.24 Calibration of Reactive Targets

4.24.1 Reactive targets must physically react to score. All reactive targets in a Sanctioned Match, poppers, plates, etc., will be calibrated so they will react properly with a "good hit" using the lowest power factor ammunition allowed in any division. The Match Director or designee will calibrate all reactive targets in a match before the first shot is fired in competition each day and at the Match Director's discretion throughout the match. The stage SOs can call for a reactive target calibration on their stage at any time if deemed necessary.

4.24.2 If the BUG division is supported the Match Director will provide a .380 firearm and ammunition that together does not exceed the BUG power factor (95PF.) If the BUG division is not supported the Match Director will provide a 9 mm or .38 Special firearm and ammunition that together does not exceed the lowest power-factor of any regular division (105PF.) The same firearm and ammunition combination will be used throughout the match for calibration and calibration challenges with no changes.

4.24.3 Targets must be situated to minimize shift, twist, or move during a match, so that proper calibration is not lost as the match continues.

4.24.4 To calibrate a reactive target, fire one round at the target from the most likely firing position in the stage and hit the calibration zone of the target. If the target does not react properly, change the target setup and repeat. The target must react correctly three times in a row to be deemed properly calibrated. If the calibration zone is missed, repeat this step.

4.24.5 If during a CoF a reactive target does not react properly when hit, the competitor has three choices.

4.24.5.1 The competitor shoots the target until it reacts properly, the target is scored as hit, and the stage score stands. In this case, no calibration challenge will be allowed.

4.24.5.2 The target does not react properly and the shooter does not challenge the calibration, the target is scored as a miss and the stage score stands. A challenge after the shooter knows the stage score or individual target scores will not be allowed.

4.24.5.3 The target does not react properly to a hit and the shooter wishes to challenge the calibration. The challenge must be made to the SO running the shooter, immediately after the "Range Is Clear" command is given, and before the shooter knows the stage score or the individual target scores. Challenges occurring after this point will not be allowed. Whether the shooter completed the stage or not does not affect the challenge process. When an appropriate challenge is made the reactive target

and the surrounding area will not be touched or interfered with by anyone until calibration is checked. As part of the challenge process, the SO will immediately collect 7 rounds of ammunition from those used in the stage from the shooter and these will be sent to the chronograph for testing.

- 4.24.6** If the target is touched or interfered with by match staff, MD, SOs or another competitor, the shooter will be given a reshoot.
- 4.24.7** If the target is touched or interfered with by the shooter or designee the target will be scored as a miss and the CoF will be deemed completed. If the shooter did not complete the stage then Incomplete Stage scoring will be used to determine the shooter's score for this stage.
- 4.24.8** Should the target fall without interference prior to calibration (i.e. wind, etc.) the shooter will be given a reshoot.
- 4.24.9** Calibration Checking Process
 - 4.24.9.1** One round will be fired at the reactive target calibration zone from the same position as the shooter used to engage the target.
 - 4.24.9.2** If the target is hit in the calibration zone or below and the target reacts properly, the calibration is deemed correct and the target will be scored as a miss. If the shooter did not complete the stage then Incomplete Stage scoring will be used to determine the shooter's score for the stage.
 - 4.24.9.3** If the target is hit above the calibration zone, the Calibration Checking Process failed and the shooter will be given a reshoot.
 - 4.24.9.4** If the target is hit anywhere on the score-able surface and the target does not react properly, the target calibration will be deemed improper, and the shooter will be given a reshoot after the target is recalibrated.
 - 4.24.9.5** If the target is missed, fire another round at the calibration zone.
 - 4.24.9.6** No matter what the outcome of this process may be, the shooter's ammunition will still be tested to see if it meets or exceeds power factor. Normal chronograph processes and penalties apply.

05 – Penalties Rules

5.1 Procedural Error (PE)

- 5.1.1** Adds three (3) seconds per infraction and is assessed when:
 - 5.1.1.1** A shooter fails to follow the procedures set forth in the stage description.
 - 5.1.1.2** A shooter breaks a rule of the game.
- 5.1.2** Only one (1) PE is assessed for each type of infraction in a string of fire. If the shooter commits more than one type of infraction, such as using the wrong specified hand and firing an incorrect number of shots, a separate PE is assessed for each type of infraction. There are two exceptions to the “one PE per infraction” rule.
- 5.1.3** Cover violations: a shooter may incur more than one cover PE per string of fire. The number of cover PE’s cannot exceed the number of cover positions. Regardless of the number of rounds fired or targets engaged from any position, only 1 cover PE may be assessed at each position.
- 5.1.4** The second exception is for reload violations as detailed in rule 3.8. The shooter can receive one PE for each incorrect reload in a string.

- 5.2** Course of Fire (CoF): A CoF will be defined as beginning at the point the Safety Officer issues the “Range Is Hot, Eyes and Ears” command to the shooter. The CoF will continue to the point the SO issues the “If finished, unload and show clear” command. If the shooter indicates they are NOT finished and continues

shooting, the CoF will continue until the “If finished, unload and show clear” command is accepted by the shooter.

5.2.1 CoF penalties will apply during the time the CoF is in progress.

5.2.2 Safety Penalties will apply prior to, during, and after the CoF.

5.3 Any target engaged with the use of an active laser or firearm mounted light will incur one (1) PE for each target shot at using an active laser or firearm mounted light.

5.4 Mobility-challenged shooters who choose not to perform an action required by the CoF (kneeling, prone, etc.) will received one (1) PE per action not performed. If the shots cannot be taken safely or the targets cannot be acquired without performing the required action, then the shooter will receive one (1) PE per target, plus the points down per target, without receiving a Failure To Neutralize (FTN).

5.5 Failure To Do Right (FTDR)

Adds twenty (20) seconds to total score and is assessed for use of inappropriate devices and unfair actions.

Note: The FTDR is intended to be used solely as a penalty for deliberate attempts on the part of the shooter to circumvent or violate the competition rules to gain a competitive advantage. It should not be assessed for inadvertent shooter errors, or in cases where it is obvious that the shooter gained no competitive advantage by their actions. In these cases, the shooter should be assessed a PE rather than an FTDR. All FTDRs must be approved by the MD.

5.6 Disqualification (DQ):

Disqualification means the shooter may not continue in any part of the IDPA match, may not reenter in another division, and may not shoot any side matches. The shooter’s score will be reported as DQ. A shooter must be disqualified for the following reasons:

5.6.1 Unsafe firearm handling as defined in the Safety Rules Section.

5.6.2 Receiving more than one FTDR during a single match.

5.6.3 Unsportsmanlike conduct

5.6.4 Violations of the Shooter’s Code of Conduct

5.6.5 Shooting at a steel target that is less than 10 yards from the shooter.

5.7 All DQs must be confirmed by the MD

06 – Stage Design Rules

6.1 A Stage Description cannot override the rulebook except under the following conditions:

6.1.1 To address a safety concern as it applies to the limits of the range

6.1.2 Provide the option of not wearing a concealment garment.

6.1.3 Specify the number of rounds in the firearm at the start of the stage, up to division capacity.

6.1.4 Specify the start condition and position for the firearm, and the start position for ammunition feeding devices.

6.1.5 Specify the shooter start position.

6.2 IDPA stages are divided into two general categories:

6.2.1 Scenario Stages - A stage that attempts to represent a target engagement that could actually happen. Scenario stages must have a written scenario description and must use Unlimited Scoring.

6.2.2 Standards-type Stages - Any stage that is designed to test the shooter's performance of the various techniques employed in IDPA shooting. Standards stages may use Limited or Unlimited scoring, and may require Loaded Chamber/Cylinder Reloads on the clock.

6.3 No foot-fault lines may be used on any scenario stage, however they may be used on Standards stages.

6.4 Stage boundaries must be defined at each stage, located no more than 10 yards (9.1 meters) back from the furthest up range shooting position. Rope, tape, cones, flags, etc. must physically indicate these boundaries.

6.5 Muzzle Safe Points

6.5.1 There are two types of Muzzle Safe Points used in IDPA. One is a physical point like a traffic cone or stake in the ground with a brightly colored flag or marker tape attached, or a muzzle safe point marked on a prop like a door. The second is a 180 plane that moves with the shooter through the stage. Either one can be used in a CoF or they may be combined in a single stage. See Safety rule 2.9 for specific definitions, usage and penalties.

6.5.2 When physical muzzle safe points are used they must be verbally described in the stage briefing and clearly marked within the stage. For every stage that uses them, there must be at least two (2) physical muzzle safe points on the stage. Pointing the firearm's muzzle beyond the marked muzzle safe points will result in the shooter's immediate Disqualification.

6.5.2.1 Muzzle Safe Points must be marked on doors that the shooter is required to open during the CoF. This type of muzzle safe point designates a keep out area. If the muzzle points at this keep out area while the shooter is opening the door, the shooter will be Disqualified.



6.5.3 When a 180 Muzzle Safe Plane is used it must be verbally described in the stage briefing. Pointing the firearm's muzzle beyond the 180 plane will result in the shooter's immediate Disqualification.

6.5.4 The stage description may provide additional requirements regarding muzzle safety and target engagement restrictions as the shooter proceeds through the stage.

6.6 Only official IDPA cardboard targets or IDPA approved targets can be used in any IDPA stage.

6.7 Seventy-five percent (75%) of all shots required in a match must be fifteen (15) yards (13.7 meters) or less.

6.7.1 Scenario stages may have shots up to 25 yards (22.9 meters) from the shooter.

6.7.2 Standards stages may have shots up to 35 yards (32 meters) from the shooter. Standards stages will not require more than 6 shots per stage at targets that are further than 25 yards from the shooter.

6.8 At least 5% of all shots required in a match are to be fired on the move.

6.9 No more than 25% of the shots required on any string of fire may be on steel targets. No more than 10% of the total shots required in the match may be on steel. Activator steel with a scored target in front of it does not count towards the allowable percentage of steel.

6.9.1 Activators located behind a score-able target must activate from shots which hit either the upper or lower zero down scoring zones. If this is not possible, the zero down zone that will not activate the activator must be identified as hardcover.

6.9.2 While blind stages are not allowed in IDPA, portions of a stage can have moveable non-threat indicators to allow for a shooter to make a shoot/no shoot decision as part of the CoF. These targets must be hidden from the view of the shooter prior to reaching the shooting position where the shoot/no shoot decision is made. In order to maintain a level playing field for all shooters, the first target and the last target will not be eligible as non-threats.

6.10 No string of fire may exceed a maximum requirement of eighteen (18) rounds.

6.10.1 String of Fire: A section of the course of fire that is initiated by a start signal, and ends with the last shot fired. There may be more than one string in a given stage.

6.11 Shooter movement under his/her own power of more than ten (10) yards (9.1 meters) between firing points is not permitted. Total shooter movement under his/her own power of more than fifteen (15) yards (13.7 meters) is not permitted.

6.12 If low cover or a prone position is required, it must be the last shooting position of a string of fire.

6.12.1 Stage designers should strive to design stages that leave targets visible for mobility challenged and physically disabled shooters.

6.13 Only one (1) non-threat target may be used for every two (2) threat targets in any string of fire.

Example:	1-2 threat targets = 1 non-threat target.
	3-4 threat targets = 2 non-threat targets.
	5-6 threat targets = 3 non-threat targets.
	7-8 threat targets = 4 non-threat targets, etc.

6.14 No threat target shall be located so that it can be hit by shooting through another threat target.

6.15 The last target in any course of fire must not be a disappearing target.

6.16 No stage shall be designed such that an ammunition feeding/loading device must be loaded during the CoF on the clock.

6.17 A disappearing target is defined as any target that, when at rest, does not present the shooter with at least one of the minimum scoring zones as defined below:

6.17.1 An unobstructed minimum of 50% of the IDPA target “head.”

6.17.2 An unobstructed portion of the IDPA target “body” such that the “straight line” edge of the target vision barrier is located no further outward on the target than the edge of the “zero down” center scoring circle.

6.17.3 See the figure below for examples of non-disappearing targets.

Examples Of Non-Disappearing Targets

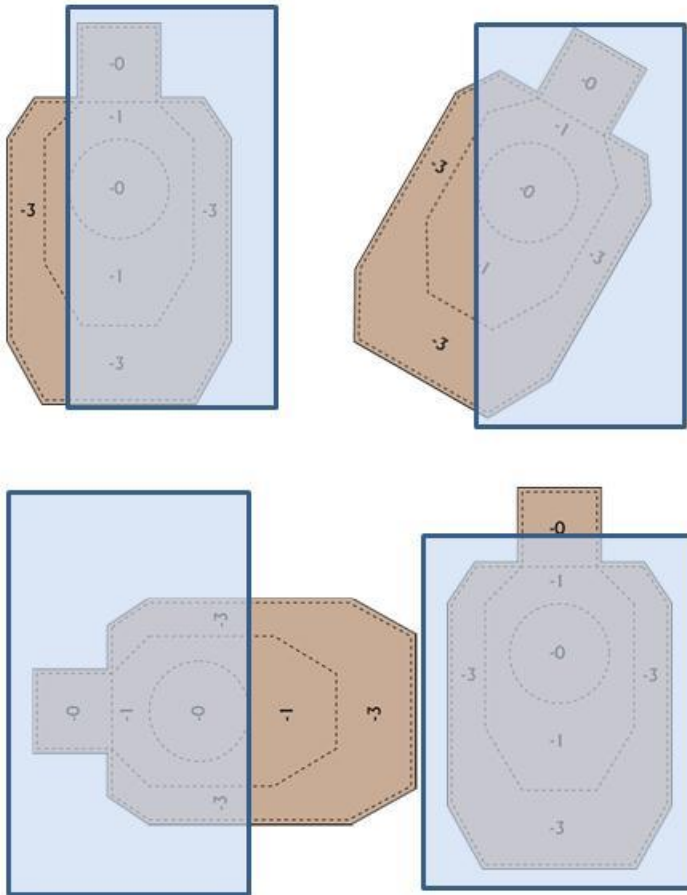

6.18 Painted hard cover is not allowed to cover the path of a moving target. If hard cover is required for the path of a moving target, it must be made of a material that will not allow a bullet to pass through the hard cover and impact the moving target.

6.19 No “strong-hand only” strings of fire may require the shooter to engage targets more than ten (10) yards (9.1 meters) distant.

6.20 No “weak-hand only” strings of fire may require the shooter to engage targets more than seven (7) yards (6.4 meters) distant.

6.21 Weak Hand Only strings will not be designed that require the shooter to use only the weak/support hand to reload the firearm. Both hands can always be used for malfunction clearance, safety issues and reloading,

no matter which hand or hands are required to shoot the string. Exception: See Permanently Physically Disabled Shooters section.

6.22 Cardboard targets at ten (10) yards (9.1 meters) or less from the shooter must present a portion of the upper or lower down zero zone to the shooter. A contiguous surface of least eighteen (18) square inches (116.1 square centimeters) of either the upper or lower down zero zone must be presented to the shooter. The smallest dimension of the required down zero area presented to the shooter must equal or exceed three (3) inches (76.2mm). (Example: half a head target.)

6.23 No shots are to be required at distances greater than ten (10) yards (9.1 meters) for targets head sized or smaller.

6.24 Any required Loaded Chamber/Cylinder Reloads on a Scenario stage must be performed off the clock. Loaded Chamber/Cylinder Reloads may be required “on the clock” in Standards stages, such as the IDPA Classifier.

6.25 In order for a PE to be assessed for failure to use a prop correctly, there must be a defined, measureable qualifier for how the prop is to be used appropriately. Under no circumstances is a PE to be assessed based on a judgment call on whether or not the prop was used appropriately during the CoF. The qualifier must be of a pass/fail determinant.

6.26 Long Guns and Pickup Guns

6.26.1 Long guns may not be fired in IDPA matches, but inert (non-firing) long guns may be used as props.

6.26.2 Pickup handguns provided by the match, match sponsors, or organizers may be used in IDPA matches. Pickup handguns do not need to be compliant with IDPA equipment rules.

6.26.3 If a shooter has a firearm malfunction using a pickup gun the shooter must re-shoot the string.

6.27 In a Scenario CoF, no more than 6 shots may be required to be fired in any one continuous “in the open” sequence of target engagements.

6.28 Vision Barriers

6.28.1 Vision barriers are soft cover objects such as tents, fake trees, walls, etc., that are used to block the view of a target or group of targets.

6.28.2 Vision barriers are soft cover and may not be impenetrable or designated as hard cover.

6.28.3 Vision barriers may not be designated as a point of cover for engaging targets or reloading, i.e. no slicing the pie around a vision barrier.

6.28.4 Vision barriers may be used by Match Directors to hide “Surprise” targets, which are to be engaged “in the open” (i.e. after leaving a “position of cover” in a CoF).

6.28.5 Humanoid shapes of any kind either partial or whole may not be used as vision barriers, soft cover or hard cover. Tactical dummies or mannequins may still be used as props, but not as Vision Barriers, soft cover or hard cover.

07 – Permanently Physically Disabled Shooters Rules

7.0.1 For IDPA purposes, a permanently physically disabled shooter is defined as having:

7.0.1.1 Missing limbs

7.0.1.2 Prosthetic limbs

7.0.1.3 Non-operational limbs

7.0.1.4 Use of wheelchair, walker or crutches

7.0.2 In an effort to accommodate our permanently physically disabled shooters, the following rules apply.

7.1 Permanently physically disabled shooters who choose not to, or are unable to perform an action required by the CoF (kneeling, prone, etc.) will receive one (1) PE penalty per action not performed. If the shots cannot be taken safely or the targets cannot be acquired from their position of ability, they will receive one (1) additional PE penalty per target. No points down or FTNs will be assessed.

7.2 Permanently physically disabled shooters with the use of only one arm or hand may elect to use a light mounted on the firearm prior to the start signal, with no penalty, on stages requiring the use of a flashlight.

7.3 Permanently physically disabled shooters who are one-armed/one-handed will not be penalized on a stage that requires shooting either weak hand or strong hand.

7.4 Permanently physically disabled shooters may perform one-handed reloads in a manner that is deemed safe by the CSO or MD prior to the start of the match.

7.5 Permanently physically disabled shooters who are confined to a wheelchair may use whatever means they choose to navigate the CoF in their wheelchair. This includes, but is not limited to electric wheelchairs, body mounted holsters or use of a wheelchair mounted holster and ammunition carriers.

7.6 Permanently physically disabled shooters may choose to shoot an array in a CoF, holster, roll to the next position, and draw for the next array, or they may choose to roll with their support hand and keep the gun in their dominant hand throughout the CoF, while being aware of the muzzle direction at all times. It is recommended that permanently physically disabled shooters alert the SO of their probable direction of movement.

7.7 Shooters who suffer from hearing loss may request an alternate non-audible start signal. Acceptable non-audible start signals are the use of hand signals, touching the shooter to indicate the audible start signal has sounded, use of a start signal light, or other visual signal to indicate the start of a CoF as determined by the CSO or MD.

7.8 IDPA Headquarters may issue individual waivers to allow physically disabled shooters to use alternate or specially designed equip to suit their individual abilities.

08 – Equipment Rules

8.1 Firearms - General

8.1.1 Division Summary

- 8.1.1.1** IDPA is divided into six (6) regular divisions that are entirely separate. None of the following divisions compete against any other division: Stock Service Pistol (SSP); Enhanced Service Pistol (ESP); Custom Defensive Pistol (CDP); Compact Carry Pistol (CCP), Revolver (REV) and BUG. Back Up Gun (BUG) is a required division for Tier 1 matches and is an optional division for Tier 2 – Tier 5 Sanctioned matches. Not For Competition (NFC) is an optional division for local matches only.
- 8.1.1.2** Double action, double action only and striker fired semi-automatic firearms compete in SSP, CCP, or BUG. Any firearm that can be used in SSP can be used in ESP or CDP, depending upon the cartridge used. Single action semi-automatic firearms compete in ESP, CCP, CDP, or BUG, depending upon physical size and cartridge used. Revolvers are classified by loading method and ammunition power and also compete in BUG depending upon physical size and cartridge used.

8.1.2 Magazine Loading

- 8.1.2.1** All magazines must be loaded to division capacity at the start signal throughout the match except in the following cases:
- 8.1.2.2** If a magazine is used that holds less than division capacity, the shooter will load all magazines to the capacity of the lowest magazine throughout the match.
- 8.1.2.3** The CoF description may require reduced magazine loading.
- 8.1.2.4** In the Revolver division the shooter must load the revolver and all loading devices with the same number of rounds throughout the match unless the above loading exceptions apply.

8.1.3 Division Capacity

- 8.1.3.1** SSP – 10 rounds
- 8.1.3.2** ESP – 10 rounds
- 8.1.3.3** CDP – 8 rounds
- 8.1.3.4** CCP – 8 rounds
- 8.1.3.5** REV – 6 rounds
- 8.1.3.6** BUG – 6 rounds total

- 8.1.3.7** In SSP, ESP, CCP, and CDP, and semi-auto BUG the shooter will also start with one round in the chamber, unless the CoF description requires otherwise.

8.1.4 Loading Device (Magazine, Speed Loader, Moon Clip) Count

- 8.1.4.1** Shooters starting with 8 or more rounds in all loading devices are allowed to start with the loaded firearm plus two additional loading devices.
- 8.1.4.2** Shooters starting with 6 or 7 rounds in all loading devices are allowed to start with the loaded firearm plus three additional loading devices.
- 8.1.4.3** Shooters starting with 5 or fewer rounds in all loading devices are allowed to start with the loaded firearm plus four additional loading devices.
- 8.1.4.4** No additional loading devices beyond the above limits may be used during a string.

8.1.5 Unserviceable Firearm Rule

- 8.1.5.1** In any single match, a shooter must use the same firearm for all stages unless it becomes unserviceable.
- 8.1.5.2** If the shooter determines that the firearm has become unserviceable, he will notify a Safety Officer who will notify the Match Director.
- 8.1.5.3** Once the shooter declares the firearm is unserviceable, it may not be used for the duration of the match.

- 8.1.5.4** The shooter may continue the match at the next start signal. Previous strings may not be re-shot.
- 8.1.5.5** Any same-division legal replacement firearm may be used.
- 8.1.5.6** If the replacement firearm magazines do not allow the same loading capacity as the original firearm, the shooter may adjust the magazine loading to suit the replacement firearm, following the magazine loading rules in Section 8.1.2.
- 8.1.6** Legal Modifications for All Divisions
 - 8.1.6.1** Storage locks may be disabled or removed.
 - 8.1.6.2** Magazine disconnects may be disabled or removed.
 - 8.1.6.3** Lasers that are incorporated into the firearm or sights are allowed if they comply with all other division rules and the laser is not activated during a string of fire. Tape may be used to prevent the laser from projecting.
 - 8.1.6.4** An extended magazine release button may not be oversized in diameter or protrude more than 0.2” (5.1 mm) out from the frame. The measurement is taken at the rear most part of the magazine release, where it exits the frame. When the magazine release area is recessed into the grip frame, the grip frame to the rear of the recess is used as the base of the measurement.
 - 8.1.6.5** With respect to slide machining, SSP, ESP, CCP, CDP and BUG, Original Equipment Manufacturer (OEM) firearms with extensive slide machining are approved for use in IDPA if they meet all other requirements for their respective Divisions. For slide machining, an OEM product is defined as a complete firearm product, with specific model part numbers or SKUs catalogued as stock items by the manufacturer and have a minimum annual production of 2,000 units for that specific model. Discontinued models must have had a total production of 20,000 units for a specific model.
- 8.1.7** Non-IDPA-Legal Features and Modifications for All Divisions

The following features and modifications are not allowed in any division unless otherwise specifically allowed in the rulebook.

 - 8.1.7.1** Compensators of any type including hybrid or ported barrels.
 - 8.1.7.2** Add-on weights. This includes (but is not limited to) weighted magazines, tungsten guide rods, brass magazine wells, weighted grips, and weighted grip plugs.
 - 8.1.7.3** Sights of non-standard configuration (ghost rings, Bo-Mar ribs, etc.).
 - 8.1.7.4** Disconnecting or disabling of any safety device including (but not limited to): manual safeties, grip safeties, firing pin, striker, and hammer blocking safeties, 1911 series 80 firing pin safeties, 1911 Swartz safeties. 1911 series 80 frames may be used with series 70 slides or vice versa. Revolver actions may not be modified so that the hammer can fall when the cylinder is open.
 - 8.1.7.5** Lights mounted on firearms.
 - 8.1.7.6** Rail mounted lasers and bolt-on trigger guard mounted lasers are not allowed.

8.2 Firearms - Divisions

8.2.1 Stock Service Pistol Division (SSP)

8.2.1.1 Handguns permitted for use in SSP must:

- 8.2.1.1.1** Have a minimum annual production of 2,000 units. Discontinued models must have had a total production of 20,000 units.
- 8.2.1.1.2** Be semi-automatic.
- 8.2.1.1.3** Be double action, double action only, or striker fired.
- 8.2.1.1.4** Use 9 mm (9x19) or larger cartridges.
- 8.2.1.1.5** The unloaded firearm with the heaviest magazine must weigh 43.00 oz. (1219.0 grams) or less.

8.2.1.1.6 The firearm with the largest magazine inserted must fit in the IDPA gun test box measuring 8 3/4" x 6" x 1 5/8" (222.3 mm x 152.4 mm x 41.3 mm.)

8.2.1.2 Start Condition:

8.2.1.2.1 Selective DA/SA firearms will start hammer down.

8.2.1.2.2 Firearms with a de-cocking lever or button will be de-cocked using the lever or button.

8.2.1.2.3 If the hammer must be lowered by pulling the trigger and manually lowering the hammer, the hammer will be lowered to the lowest position possible.

8.2.1.2.4 In SSP, manual safeties may be engaged at the shooter's discretion.

8.2.1.3 SSP Permitted Modifications (Inclusive list):

8.2.1.3.1 Sights may be changed to another notch and post type. Slides may not be machined to accept different style sights.

8.2.1.3.2 Grips may be changed to another style or material that is similar to factory configuration and do not weigh more than 2.00 oz. (56.7 grams) more than the factory standard weight for that model.

8.2.1.3.3 Magazine releases, slide stops, safety levers, de-cocking levers, hammers, and triggers, that are stock on one SSP legal firearm may be used on another SSP legal firearm from the same manufacturer provided they are drop in replacements. Parts in this list must come factory installed on standard production firearms. Special parts that are available installed only from a factory custom shop are not eligible in SSP.

8.2.1.3.4 Recoil spring guide rods and dual spring recoil systems made of material that is no heavier than stainless steel.

8.2.1.3.5 Frames may be replaced with identical frames from the same manufacturer.

8.2.1.3.6 A slip-on grip sock and/or grip tape, skateboard tape, etc. may be used.

8.2.1.3.7 Internal action work may be used to enhance trigger pull as long as safety is maintained (no visible external modifications allowed).

8.2.1.3.8 Internal reliability work.

8.2.1.3.9 Aftermarket extractors and pins may be used.

8.2.1.3.10 Internal accuracy work.

8.2.1.3.11 Replacement of barrel with one of factory configuration that uses the original cartridge.

8.2.1.3.12 Plastic plugs may be used to fill the opening behind the magazine well.

8.2.1.3.13 Custom finishes may be applied.

8.2.1.3.14 Stock slide cover plates may be refinished.

8.2.1.3.15 Slides may be engraved. Engraving is defined as etching into the slide of logos, letters, and graphics no deeper than the original factory logos.

8.2.1.3.16 Stippling and texturing may be performed on readily replaceable parts of the grip frame such as replaceable back straps and replaceable grip panels.

8.2.1.3.17 Aftermarket magazines may be used provided they do not weigh more than 1.00 oz. (28.3 grams) over the same capacity factory magazine.

8.2.1.3.18 Aftermarket magazine base pads may be used provided they do not make the magazine weight more than 1.00 oz. (28.3 grams) over the same capacity factory magazine.

8.2.1.3.19 Magazine base pads may be modified by reshaping, texturing, or adding bumper pads provided that they do not make the magazine weigh more than 1.00 oz. (28.3 grams) over the same capacity factory magazine.

8.2.1.3.20 Magazines that are longer than stock may be used provided they meet all other division requirements.

8.2.1.4 SSP Excluded Modifications (Non-Inclusive list):

8.2.1.4.1 Externally visible modifications other than those listed in the Permitted Modifications section.

8.2.1.4.2 Aftermarket or visibly modified magazine releases, slide stops, safety levers, de-cocking levers, and hammers.

8.2.1.4.3 Robar-style grip reduction.

- 8.2.1.4.4** Add-on magazine well opening.
- 8.2.1.4.5** Slide inserts to accommodate a different recoil assembly design.
- 8.2.1.4.6** A barrel that uses a different cartridge that is not offered in the original factory model.
- 8.2.1.4.7** Customization of the slide by adding front cocking serrations, tri-top, carry melts, and high power cuts.
- 8.2.1.4.8** Compensated/ported firearms with non-compensated/ported barrels installed.
- 8.2.1.4.9** Checkering or stippling on non-readily replaceable parts of the grip frame.
- 8.2.1.4.10** Aftermarket slides.
- 8.2.1.4.11** Removing material from the magazine well opening.
- 8.2.1.4.12** Aftermarket grip tang extensions or beavertails.
- 8.2.1.4.13** Disabling the slide stop.

8.2.2 Enhanced Service Pistol Division (ESP)

8.2.2.1 Handguns permitted for use in ESP must:

- 8.2.2.1.1** Be semi-automatic.
- 8.2.2.1.2** Use 9 mm (9x19) or larger cartridges.
- 8.2.2.1.3** The unloaded firearm with the heaviest magazine must weigh 43.00 oz. (1219.0 grams) or less.
- 8.2.2.1.4** The firearm with the largest magazine inserted must fit in the IDPA gun test box measuring 8 ³/₄" x 6" x 1 ⁵/₈" (222.3 mm x 152.4 mm x 41.3 mm.)
- 8.2.2.1.5** Firearms originally sold as compensated/ported models may be used in ESP with non-compensated/ported barrels installed.
- 8.2.2.1.6** Start Condition:
 - 8.2.2.1.6.1** Single action only firearms will start cocked and locked. (hammer cocked, safety engaged).
 - 8.2.2.1.6.2** Selective DA/SA firearms will start cocked and locked or de-cocked. This is at the shooter's discretion, including firearms using the SSP into ESP rule.
 - 8.2.2.1.6.3** Double action, double action only, or striker fired firearms with a de-cocking lever or button will be de-cocked using the lever or button.
 - 8.2.2.1.6.4** Double action, double action only, or striker-fired firearms may have a manual safety engaged at the shooter's discretion.
- 8.2.2.1.7** All firearms legal in SSP are legal for use in ESP. This provision may be used for firearms that violate an ESP rule (for example, a firearm with a steel dust cover or rail over 3.25") to still be used in ESP, provided the firearm meets all SSP requirements.

8.2.2.2 ESP Permitted Features and Modifications (Inclusive list):

- 8.2.2.2.1** Sights may be changed to another notch and post type. Slides may be machined to accept different style sights.
- 8.2.2.2.2** Grips may be changed provided they do not weigh more than 2.00 oz. (56.7 grams) more than the factory standard weight for that model.
- 8.2.2.2.3** A slip-on grip sock and/or grip tape, skateboard tape, etc. may be used.
- 8.2.2.2.4** Robar-style grip reduction.
- 8.2.2.2.5** Action work may be used to enhance trigger pull as long as safety is maintained.
- 8.2.2.2.6** Reliability work.
- 8.2.2.2.7** Aftermarket extractors and pins may be used.
- 8.2.2.2.8** Internal accuracy work.

- 8.2.2.2.9** Replacement of barrel with one of factory configuration that uses a stock or non-stock cartridge.
- 8.2.2.2.10** Plastic plugs may be used to fill the opening behind the magazine well.
- 8.2.2.2.11** Aftermarket triggers and trigger work that result in the trigger being forward or rearward from the stock trigger position.
- 8.2.2.2.12** Externally visible trigger over travel stops.
- 8.2.2.2.13** Hammer and other trigger action parts to enhance trigger pull.
- 8.2.2.2.14** Checkering, serrating, and stippling.
- 8.2.2.2.15** Reshape trigger guard.
- 8.2.2.2.16** Extended and/or ambidextrous thumb safety.
- 8.2.2.2.17** Extended beavertail grip safety.
- 8.2.2.2.18** Ambidextrous or right side magazine releases.
- 8.2.2.2.19** Extended, trimmed, and/or ambidextrous slide releases.
- 8.2.2.2.20** Heavy or cone style barrels on firearms with barrel lengths of 4.25” (108 mm) or less.
- 8.2.2.2.21** Recoil spring guide rods and dual spring recoil systems made of material that is no heavier than stainless steel.
- 8.2.2.2.22** Slide inserts to accommodate a different recoil assembly design.
- 8.2.2.2.23** Modification of the magazine well and add-on well extensions.
- 8.2.2.2.24** Custom finishes and engraving may be applied.
- 8.2.2.2.25** Aftermarket slide cover plates.
- 8.2.2.2.26** Slides with front cocking serrations, tri-top, carry melts, and high power cuts.
- 8.2.2.2.27** Grip tang extensions or beavertails
- 8.2.2.2.28** Swenson style thumb shields and frame mounted thumb shields.
- 8.2.2.2.29** Aftermarket safeties.
- 8.2.2.2.30** Aftermarket magazine base pads may be used provided they do not make the magazine weight more than 1.50 oz. (42.5 grams) over the same capacity factory magazine.
- 8.2.2.2.31** Magazine base pads may be modified by reshaping, texturing, or adding bumper pads provided that they do not make the magazine weigh more than 1.50 oz. (42.5 grams) over the same capacity factory magazine.
- 8.2.2.2.32** Magazines that are longer than stock may be used provided they meet all other division requirements.

8.2.2.3 ESP Excluded Features and Modifications (Non-Inclusive list):

- 8.2.2.3.1** Steel dust covers and rails over 3.25” (82.6 mm) (as measured from the rear of the slide stop pin to the most forward portion of the dust cover or rail) are not permitted.
- 8.2.2.3.2** Removal of material from the exterior of the slide other than front cocking serrations, tri-top, engraving, carry melts, and high power cuts.
- 8.2.2.3.3** Trigger shoes.
- 8.2.2.3.4** Disabling the slide stop.

8.2.3 Custom Defensive Pistol Division (CDP)

8.2.3.1 Handguns permitted for use in CDP must:

- 8.2.3.1.1** Be semi-automatic.
- 8.2.3.1.2** Use .45 ACP cartridges.

- 8.2.3.1.3** The unloaded firearm with the heaviest magazine must weigh 43.00 oz. (1219.0 grams) or less.
- 8.2.3.1.4** The firearm with the largest magazine inserted must fit in the IDPA gun test box measuring 8 3/4" x 6" x 1 5/8" (222.3 mm x 152.4 mm x 41.3 mm.)
- 8.2.3.1.5** Firearms originally sold as compensated/ported models may be used in CDP with non-compensated/ported barrels installed.
- 8.2.3.1.6** Start Condition:
- 8.2.3.1.6.1** Single action only firearms will start cocked and locked. (hammer cocked, safety engaged).
- 8.2.3.1.6.2** Selective DA/SA firearms will start cocked and locked or de-cocked. This is at the shooter's discretion, including firearms using the SSP into CDP rule.
- 8.2.3.1.6.3** Double action, double action only, or striker fired firearms with a de-cocking lever or button will be de-cocked using the lever or button.
- 8.2.3.1.6.4** Double action, double action only, or striker-fired firearms may have a manual safety engaged at the shooter's discretion.
- 8.2.3.1.7** All .45 ACP firearms legal in SSP are legal for use in CDP. This provision may be used for firearms that violate a CDP rule (for example, a firearm with a steel dust cover or rail over 3.25") to still be used in CDP, provided the firearm meets all SSP requirements.
- 8.2.3.2** CDP Permitted Features and Modifications (Inclusive list):
- 8.2.3.2.1** Sights may be changed to another notch and post type. Slides may be machined to accept different style sights.
- 8.2.3.2.2** Grips may be changed provided they do not weigh more than 2.00 oz. (56.7 grams) more than the factory standard weight for that model.
- 8.2.3.2.3** A slip-on grip sock and/or grip tape, skateboard tape, etc. tape may be used.
- 8.2.3.2.4** Robar-style grip reduction.
- 8.2.3.2.5** Action work may be used to enhance trigger pull as long as safety is maintained.
- 8.2.3.2.6** Reliability work.
- 8.2.3.2.7** Aftermarket extractors and pins may be used.
- 8.2.3.2.8** Internal accuracy work.
- 8.2.3.2.9** Replacement barrels of factory configuration in .45 ACP.
- 8.2.3.2.10** Plastic plugs may be used to fill the opening behind the magazine well.
- 8.2.3.2.11** Aftermarket triggers and trigger work that result in the trigger being forward or rearward from the stock trigger position.
- 8.2.3.2.12** Externally visible trigger over travel stops.
- 8.2.3.2.13** Hammer and other trigger action parts to enhance trigger pull.
- 8.2.3.2.14** Checkering, serrating, and stippling.
- 8.2.3.2.15** Reshape trigger guard.
- 8.2.3.2.16** Extended and/or ambidextrous thumb safety.
- 8.2.3.2.17** Extended beavertail grip safety.
- 8.2.3.2.18** Ambidextrous or right side magazine releases.
- 8.2.3.2.19** Extended, trimmed, and/or ambidextrous slide releases.
- 8.2.3.2.20** Heavy or cone style barrels on firearms with barrel lengths of 4.25" (108 mm) or less.
- 8.2.3.2.21** Recoil spring guide rods and dual spring recoil systems made of material that is no heavier than stainless steel.
- 8.2.3.2.22** Slide inserts to accommodate a different recoil assembly design.
- 8.2.3.2.23** Modification of the magazine well and add-on well extensions.
- 8.2.3.2.24** Custom finishes and engraving may be applied.
- 8.2.3.2.25** Aftermarket slide cover plates.
- 8.2.3.2.26** Slides with front cocking serrations, tri-top, engraving, carry melts and high power cuts.
- 8.2.3.2.27** Grip tang extensions or beavertails

8.2.3.2.28 Swenson style thumb shields and frame mounted thumb shields.

8.2.3.2.29 Aftermarket safeties.

8.2.3.2.30 Aftermarket magazine base pads may be used provided they do not make the magazine weight more than 1.50 oz. (42.5 grams) over the same capacity factory magazine.

8.2.3.2.31 Magazine base pads may be modified by reshaping, texturing, or adding bumper pads provided that they do not make the magazine weigh more than 1.50 oz. (42.5 grams) over the same capacity factory magazine.

8.2.3.2.32 Magazines that are longer than stock may be used provided they meet all other division requirements.

8.2.3.3 CDP Excluded Features and Modifications (Non-Inclusive list):

8.2.3.3.1 Steel dust covers and rails over 3.25" (82.6 mm) (as measured from the rear of the slide stop pin to the most forward portion of the dust cover or rail) are not permitted.

8.2.3.3.2 Removal of material from the exterior of the slide other than front cocking serrations, tri-top, engraving, carry melts, and high power cuts.

8.2.3.3.3 Trigger shoes.

8.2.3.3.4 Disabling the slide stop.

8.2.4 Compact Carry Pistol Division (CCP)

8.2.4.1 Handguns permitted for use in CCP must:

8.2.4.1.1 Be semi-automatic.

8.2.4.1.2 Use 9 mm (9x19) or larger cartridges.

8.2.4.1.3 Barrel length of 4.10" (104.1 mm) or less.

8.2.4.1.4 The unloaded firearm with the heaviest magazine must weigh 37.00 oz. (1048.9 grams) or less.

8.2.4.1.5 The firearm with the largest magazine inserted must fit in the IDPA gun test box measuring 8 3/4" x 6" x 1 3/8" (222.3 mm x 152.4 mm x 34.9 mm.)

8.2.4.1.6 Start Condition:

8.2.4.1.6.1 Single action only firearms will start cocked and locked. (hammer cocked, safety engaged).

8.2.4.1.6.2 Selective DA/SA firearms will start cocked and locked or de-cocked. This is at the shooter's discretion.

8.2.4.1.6.3 Double action, double action only, or striker fired firearms with a de-cocking lever or button will be de-cocked using the lever or button.

8.2.4.1.6.4 Double action, double action only, or striker-fired firearms may have a manual safety engaged at the shooter's discretion.

8.2.4.2 CCP Permitted Features and Modifications (Inclusive list):

CCP firearms must comply with all Enhanced Service Pistol (ESP) features and modifications, and equipment restrictions, with the exception that there is no dust cover length limitations. Rule 8.2.2.3.1 does not apply.

8.2.5 Revolver Division (REV)

Revolvers will be categorized into one of the two following sub-categories:

Stock Revolver or Enhanced Revolver

8.2.5.1 Stock Revolver handguns permitted for use must be:

8.2.5.1.1 Any revolver that uses .38 Special or larger cartridges with a rimmed case and is not loaded with moon clips.

- 8.2.5.1.2** The unloaded firearm must weigh 43.00 oz. (1219.0 grams) or less.
- 8.2.5.2** Enhanced Revolver handguns permitted for use must be:
 - 8.2.5.2.1** Any revolver that uses .357 magnum or larger cartridges with rimmed or rimless cases.
 - 8.2.5.2.2** The unloaded firearm must weigh 50.00 oz. (1417.5 grams) or less.
 - 8.2.5.2.3** May be loaded via speed loader or full moon clip.
- 8.2.5.3** Stock and Enhanced Revolver requirements:
 - 8.2.5.3.1** The use of trimmed (shortened) ammunition is not allowed.
 - 8.2.5.3.2** Ammunition used must match the cartridge listed on the firearm with the following exceptions:
 - 8.2.5.3.2.1** .38 special in .357 magnum
 - 8.2.5.3.2.2** .44 special in .44 magnum
 - 8.2.5.3.2.3** .45 Auto Rim or .45 GAP in .45 ACP
 - 8.2.5.3.2.4** .45 ACP or .45 GAP in .45 Colt
 - 8.2.5.3.2.5** .40 S&W in 10mm
 - 8.2.5.3.3** Barrel length of 4.25" (108 mm) or less.
 - 8.2.5.3.4** Be loaded to the division capacity of six (6) rounds in the cylinder. Seven (7) and eight (8) shot revolvers are permitted, but may only load six (6) rounds.
- 8.2.5.4** Stock and Enhanced Revolver Permitted Modifications (Inclusive list):
 - 8.2.5.4.1** Sights may be changed to another notch and post type. The frame and barrel may be machined to accept different style sights.
 - 8.2.5.4.2** Action work to enhance trigger pull as long as safety is maintained (smoothing the trigger face, removing the hammer spur, use of over travel stop, conversion to DA only and addition of ball detent are considered action work and are permitted).
 - 8.2.5.4.3** Grips may be changed to another style or material that is similar to factory configuration, provided they do not weigh more than 2.00 oz. (56.7 grams) more than the factory standard weight for that model.
 - 8.2.5.4.4** Grip tape, skateboard tape, etc. may be used.
 - 8.2.5.4.5** Cylinder latches may be changed to another factory offering from the firearm manufacturer.
 - 8.2.5.4.6** Chamfer the rear of the chambers.
 - 8.2.5.4.7** Shortening of factory barrels.
 - 8.2.5.4.8** Re-barreling to another factory offering for that model.
 - 8.2.5.4.9** Firearms converted to accept moon clips may be used in Stock Revolver provided moon clips are not used.
 - 8.2.5.4.10** Custom finishes.
- 8.2.5.5** Enhanced Revolver Additional Permitted Modifications (Inclusive list):
 - 8.2.5.5.1** Cylinder latches may be modified or replaced, but may not protrude past the frame in any direction and may not be thicker than $\frac{3}{8}$ " (9.5 mm) as measured from the side plate of the frame.
 - 8.2.5.5.2** Conversion to accept moon clips.
- 8.2.5.6** Stock and Enhanced Revolver Excluded Modifications (Non-Inclusive list):
 - 8.2.5.6.1** Oversize or heavy barrels.
 - 8.2.5.6.2** Hogue Big Butt grips and similar are not allowed. The maximum grip dimensions allowed are:
 - 5.00" (127mm) maximum height, measured from the bottom of the hammer opening in the frame to the bottom of the grip
 - 2 $\frac{3}{8}$ " (60.3mm) maximum depth.

1 ⁵/₈" (41.3mm) maximum width

8.2.6 Back Up Gun (BUG)

8.2.6.1 The Back Up Gun division is a required division for Tier 1 matches and is an optional division that may be included as a competition division into a Tier 2 – Tier 5 Sanctioned match at the Match Director's discretion. Effective June 1, 2015.

8.2.6.2 The Back Up Gun division may also be used to create a specialty BUG only match. Match directors may prescribe conditions for courses of fire such as the start condition, holster use, and reloads on the clock.

8.2.6.3 Handguns permitted for use in BUG are categorized into one of the following sub-categories:

8.2.6.3.1 Semi-Automatic BUG.

8.2.6.3.2 Revolver BUG.

8.2.6.3.3 Other Special Sub-Categories as defined by the MD.

8.2.6.4 All BUG Permitted Modifications (Inclusive list):

8.2.6.4.1 Storage locks may be disabled or removed.

8.2.6.4.2 Magazine disconnects may be disabled or removed.

8.2.6.4.3 Lasers that are incorporated into the firearm or sights are legal if they comply with all other division rules and the laser is not activated.

8.2.6.5 All BUG Excluded Modifications (Non-Inclusive list):

Refer to Non-IDPA-Legal Modifications for all Divisions

8.2.6.6 Semi-Automatic BUG (BUG-S)

8.2.6.6.1 Handguns permitted for use in BUG-S must:

8.2.6.6.1.1 Be semi-automatic.

8.2.6.6.1.2 Be single action, double action, double action only, or striker fired.

8.2.6.6.1.3 Use .380 ACP or larger cartridges.

8.2.6.6.1.4 Barrel length of 3.60" (91.4 mm) or less.

8.2.6.6.1.5 The unloaded firearm with the heaviest magazine must weigh 29.00 oz. (822.1 grams) or less.

8.2.6.6.1.6 The firearm with the largest magazine inserted must fit in the IDPA gun test box measuring 7 ¹/₄" x 5 ¹/₂" x 1 ³/₈" (184.2 mm x 139.7 mm x 34.9 mm.)

8.2.6.6.1.7 Magazine length (tubes plus base pad) that extend no more than 1.0" (25.4 mm) beyond the bottom of the grip.

8.2.6.6.2 Start Condition:

8.2.6.6.2.1 Single action only firearms will start cocked and locked. (hammer cocked, safety engaged).

8.2.6.6.2.2 Selective DA/SA firearms will start cocked and locked or decocked at the shooter's discretion.

8.2.6.6.2.3 When decocking is desired, firearms with a decocking lever or button will be decocked using the lever or button.

8.2.6.6.2.4 When decocking is desired, if the hammer must be lowered by pulling the trigger and manually lowering the hammer, the hammer will be lowered to the lowest position possible.

8.2.6.6.2.5 In BUG semi-auto the shooter will start with one round in the chamber and 5 rounds in the magazine, and 6 rounds in each additional magazine.

8.2.6.6.3 Semi-Automatic Modifications:

Semi-automatic BUG must comply with all Enhanced Service Pistol (ESP) features and modifications, and equipment restrictions.

8.2.6.7 Revolver BUG (BUG-R)

8.2.6.7.1 Handguns permitted for use in BUG-R must be:

8.2.6.7.1.1 Any revolver that uses .38 or larger cartridges with a rimmed case and is not loaded with moon clips.

8.2.6.7.1.2 The use of trimmed (shortened) ammunition is not allowed.

8.2.6.7.1.4 Barrel length of 3.0" (76.2 mm) or less (as measured from the front of the cylinder).

8.2.6.7.1.5 The unloaded firearm must weigh 38.00 oz. (1077.3 grams) or less.

8.2.6.7.1.6 Be loaded to the division capacity of six (6) rounds in the cylinder.

8.2.6.7.1.7 The firearm must fit in the IDPA gun test box measuring 8 ³/₄" x 5 ¹/₂" x 1 ⁵/₈" (222.3 mm x 139.7 mm x 41.3 mm.)

8.2.6.7.2 Revolver BUG Modifications:

Revolver BUG must comply with all Stock Revolver features and modifications, and equipment restrictions.

8.2.7 Not For Competition (NFC)

8.2.7.1 IDPA encourages shooters to practice their gun handling skills with commonly carried firearms. Many everyday carry firearms do not fit into the 5 competition divisions.

8.2.7.2 IDPA allows clubs to add a "Not for Competition" scoring division for Tier 1 matches only. This division allows cartridges smaller than 9 mm, carry optics, activated lasers, non-illuminated mounted lights, and other pistols which do not fit into the other competition divisions to participate in local club matches.

8.2.7.3 All other IDPA equipment rules apply for holsters and loading device holders as well as their placement on the body. Match Directors also have the option to allow junior shooters with .22 rimfire firearms to begin strings at low ready in lieu of requiring a holster.

8.2.7.4 All IDPA membership rules apply.

8.2.7.5 Clubs are not required to implement this provision, and Match Directors are allowed discretion with implementation so that match quality remains high.

8.3 Ammunition

8.3.0.1 Metal piercing, incendiary, and tracer ammunition is prohibited.

8.3.0.2 Clubs may prohibit cartridges that may damage metal targets.

8.3.0.3 All ammunition must use a single projectile.

8.3.1 Ammunition Power

The goal is to compete with commonly available ammunition. The minimum power factors are:

8.3.1.1 SSP - 125

8.3.1.2 ESP - 125

8.3.1.3 CCP - 125

8.3.1.4 CDP - 165

8.3.1.5 Stock REV 105 Enhanced REV - 155

8.3.1.6 BUG - 95

8.3.1.7 Calculate the power factor by multiplying the bullet weight in grains by the bullet velocity in feet per second (fps), divide by 1000, and ignore numbers to the right of the decimal. For example, a 230.1 grain bullet at 794.7 fps: 230.1 x 794.7 / 1000 = 182.86047, or 182 power factor.

8.3.2 Official Chronograph Procedure

8.3.2.1 If the chronograph is conducted without the competitor present, (pulling and/or bagging ammunition to chronograph) where the chronograph official uses match-supplied firearms, the following procedure will be used:

8.3.2.1.1 Chronograph three rounds at a distance of ten (10) feet (3 meters) using a firearm of maximum barrel length for the division. If two of the three rounds meet or exceed the required power factor, the ammunition is in compliance. Prior to each shot, the muzzle of the firearm will be elevated to vertical (if range rules permit) to move the powder charge to the rear of the case, thus giving the competitor every chance to achieve maximum velocity.

8.3.2.1.2 If the competitor's ammunition fails to make power factor, the competitor will have the option to chronograph three additional rounds through his/her own firearm or another firearm of maximum barrel length for the division. Prior to each shot, the muzzle of the firearm will be elevated to vertical (if range rules permit) to move the powder charge to the rear of the case. If two of the six rounds fired meet or exceed the required power factor, the ammunition is in compliance.

8.3.2.1.3 It is not the match organizers' responsibility to provide a firearm of every type and caliber. If the match officials can, they may provide or borrow one from a match competitor and reattempt to pass the chronograph. However, if a suitable substitute cannot be obtained, the second attempt must be made using the competitor's firearm. It is ultimately the responsibility of the competitor to insure his/her ammo will make power factor.

8.3.2.1.4 A bullet will be pulled and weighed using a powder scale.

8.3.2.1.5 A firearm used for chronograph purposes must be legal in the same division as the shooter's firearm.

8.3.2.1.6 A competitor whose ammunition fails to make power factor will be allowed to shoot the match, but their total score will be a Disqualification.

8.3.2.2 If the chronograph is operated as a station within the match where the competitor's own firearm is used, the following procedure will be used:

8.3.2.2.1 Chronograph three rounds at a distance of ten (10) feet (3 meters) using the competitor's firearm. If two of the three rounds meet or exceed the required power factor, the competitor is in compliance. Prior to each shot, the muzzle of the firearm will be elevated to vertical (if range rules permit) to move the powder charge to the rear of the case.

8.3.2.2.2 If the competitor's ammunition fails to make power factor, the competitor will have the option to chronograph three additional rounds using his/her firearm or a firearm of maximum barrel length for the division. Prior to each shot, the muzzle of the firearm will be elevated to vertical (if range rules permit) to move the powder charge to the rear of the case. If two of the six rounds fired meet or exceed the required power factor, the ammunition is in compliance.

8.3.2.2.3 It is not the match organizers' responsibility to provide a firearm of every type and caliber. The logistics of this could be almost impossible. If the match officials can, they may provide the firearm or borrow one from a match competitor and reattempt to pass the chronograph. However, if a suitable substitute cannot be obtained, the second attempt must be made using the competitor's firearm. It is ultimately the responsibility of the competitor to insure his/her ammunition will make power factor.

8.3.2.2.4 A bullet will be pulled and weighed using a powder scale.

8.3.2.2.5 A competitor whose ammunition fails to make power factor will be allowed to shoot the match, but their total score will be a Disqualification.

8.4 Belts

Belts may be no wider than 1 ¾ inches (44.5 mm) or thicker than 5/16 inches (7.9 mm) and must pass through a minimum of all but two of the pant loops.

8.5 Holsters

8.5.1 Criteria of an IDPA Legal Holster / Holster Requirements:

- 8.5.1.1** Must be suitable for concealed carry and all day continuous wear.
- 8.5.1.2** Must be a strong side hip holster worn inside the waistband (IWB) or outside the waist band (OWB).
- 8.5.1.3** Must be worn on an IDPA legal belt.
- 8.5.1.4** Must prevent activation of the trigger while holstered.
- 8.5.1.5** Must carry the firearm in a neutral (vertical) or muzzle rear cant.
- 8.5.1.6** Adjustable cant holsters are legal if bolts must be removed and repositioned for cant adjustment. Inside the waistband (IWB) holsters are exempt from this rule.
- 8.5.1.7** Must hold the firearm with enough tension to allow the wearer to complete normal daily tasks without fear of losing the firearm.
- 8.5.1.8** Must be constructed of normal thickness common holster making materials (leather, Kydex, plastic, nylon, etc.).
- 8.5.1.9** For male shooters, the holster must carry firearm so that the entire front strap (to the trigger guard) is at or above the top of the belt. IWB holsters are exempt from this rule.
- 8.5.1.10** The shooter's holster location must remain on the same side of the body throughout the entire course of a match.
- 8.5.1.11** Must be positioned on the belt so that the center of the trigger pad is behind the centerline of the body.
- 8.5.1.12** For IDPA purposes, the centerline of the body originates in the center of the armpit and goes straight down.
- 8.5.1.13** All retention devices on the holster must be used.
- 8.5.1.14** Retention devices may be permanently removed or permanently disabled, but not temporarily disabled for a match.
- 8.5.1.15** The front edge of the holster may not be more than 1 ¾ inch/44.5mm below the breech face (autos) or 1 inch/25.4mm below the rear of the cylinder (revolvers).
- 8.5.1.16** Holsters may be modified to meet IDPA rules.
- 8.5.1.17** For male shooters only, the holsters must fit the shooter's body such that a ¾ inch/19.1mm diameter dowel placed between the shooter and the firearm anywhere above the belt contacts both the shooter and the firearm simultaneously.
 - 8.5.1.17.1** A holster may be legal for some shooters but not legal for other shooters due to different body shapes.
 - 8.5.1.17.2** A holster may be legal if worn snugly but illegal if sagging away from the body.
 - 8.5.1.17.3** For women shooters only, a dropped and offset (DOH) holster may be used. For the drop, the gun must be covered by the concealment garment. Holster cant rules apply.
 - 8.5.1.17.4** For women shooters only, when viewed from the front, a women's holster may not tilt out away from the body further than vertical, unless the shooter's body touches the grip of firearm.
- 8.5.1.18** Not Permitted (Non-Inclusive list):
 - 8.5.1.18.1** Cross-draw carry
 - 8.5.1.18.2** Shoulder holsters
 - 8.5.1.18.3** Small of the back carry
 - 8.5.1.18.4** Appendix carry
 - 8.5.1.18.5** Pocket carry

Ex. 8.5.1.9 For Male Shooters the Entire Front Strap at or above top of belt



Ex. 8.5.1.15 Holster Coverage on Front of Autos

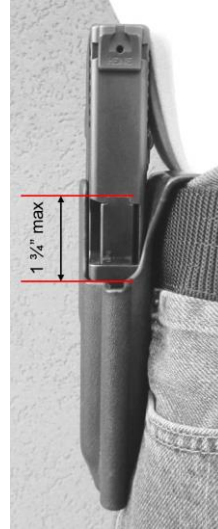

Ex. 8.5.1.17 The Dowel Test
8.5.1.17 Male Legal



8.5.1.17 Male Not Legal, fails dowel test



Ex. 8.5.1.17 Male Not Legal, fails dowel test and 8.3 illegal belt



Ex. 8.5.1.17 Female Legal



Ex. 8.5.1.17 Female Illegal, tilts away from vertical

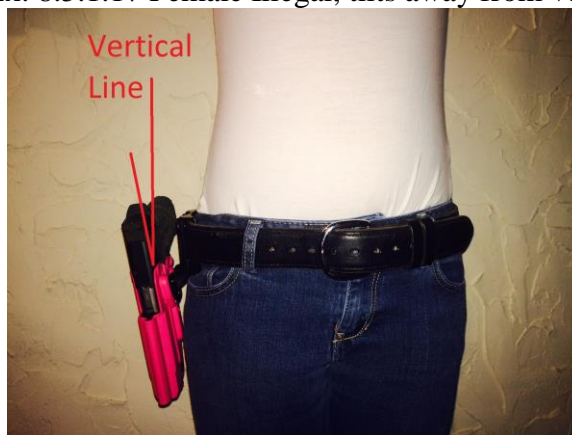

8.5.2 Holster Pictures

8.5.2.1 Examples of Inside the Waistband (IWB) Style



8.5.2.2 Examples of Outside the Waistband (OWB) style.



8.6 Ammunition Carriers

8.6.1 General Ammunition Carrier Rules

8.6.1.1 Instead of using ammunition carriers, shooters may carry spare loading devices in their pockets. Shooters may mix carry methods.

8.6.1.2 Loading devices may not be placed in chest pockets.

8.6.1.3 One ammunition carrier per allowed ammunition feeding device (see rule 8.1.4.2) may be worn on the belt. (Each individual pouch in a multiple pouch ammunition carrier counts as one.) One additional ammunition carrier may be worn behind the centerline of the body for the purposes of loading at the start of a stage. This carrier must be empty before the “Stand By” command.

8.6.1.4 Ammunition carriers may be modified to meet IDPA rules.

8.6.1.5 For male shooters only, ammunition carriers must hold the loading devices such that a 3/4 inch/19.1 mm dowel placed between the shooter and the device contacts both the shooter and the device simultaneously.

8.6.2 Magazine Carrier Rules - Magazine carriers must:

8.6.2.1 Be suitable for concealed carry and all day continuous wear.

8.6.2.2 Must be worn on an IDPA legal belt.

8.6.2.3 Cover 2” (50.8 mm) of the magazine as measured from the top of the cartridge rim down the back flat of the magazine tube.

8.6.2.4 Cover the entire outer face of the portion of the magazine inside the carrier. The outer face is the side away from the shooter’s body.

8.6.2.5 Hold the magazine within 10° of vertical relative to the belt. (80° to 100° relative to the belt).

8.6.2.6 Magazine carriers with screws or knobs that extend past the outer face of the carrier are allowed if the adjustment screw(s) require a tool to change tension, the screws protrude less than 0.125” (3.2 mm) from the outer face of the magazine carrier, and they meet all other magazine carrier requirements. Additionally, all tension screws anywhere on a magazine carrier must require a tool for tension adjustment.

8.6.2.7 “Bullets out” magazine pouches are not allowed.

8.6.2.8 Magazine carriers must be worn in a belt location where the front edge of the carrier or magazine is behind the shooter’s anterior superior iliac spine (hipbone).

8.6.2.9 The same exact location for magazines, magazine pouches, and/or ammunition feeding devices in pockets must be used for every stage in a single match, unless otherwise specified in a stage description.

Ex. 8.6.2.3 Two Inch Measurement

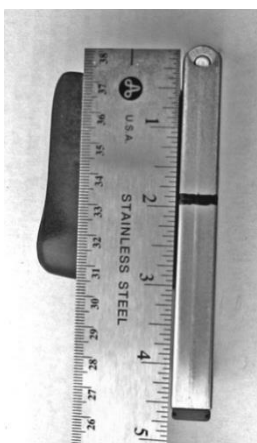

Ex. 8.6.2.4 Outer Face Entirely Covered

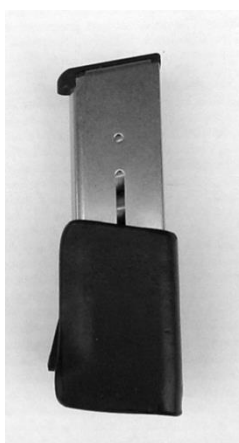

Ex. 8.6.2.4 Not Legal, outer face not entirely covered



Ex. 8.6.1.5 Not Legal fails dowel test and 8.6.2.6 has knob extending past outer face



8.6.1.5 Legal



8.6.3 Speed Loader and Moon Clip Carrier Rules

8.6.3.1 Be suitable for concealed carry and all day continuous wear.

8.6.3.2 Speed loader carriers must either be of open top configuration that covers at least 45% of the diameter and 100% of the cartridge height when viewed from the front, and must retain the speed loader by tension or retain the speed loader with a snap or Velcro closure. Side cuts are permitted for thumb and index finger access only.

8.6.3.3 Moon clip carriers must either be of open top configuration that covers at least 45% of the diameter and 100% of the cartridge height when viewed from the front, and must retain the moon clip by tension and a stud that protrudes through the center of the clip, or retains the moon clip with a snap or Velcro closure.

8.6.3.4 Moon clips may not be retained in the carrier by three (3) or less cartridges. Side cuts are permitted for thumb and index finger access only.

8.6.3.5 Two speed loaders/moon clips may be worn directly in front of the holster. The speed loaders/moon clips worn in front of the holster must be within 1" (25.4 mm) of each other, and the speed loader/moon clip nearest the holster must be within 1" of the revolver pouch of the holster.

8.6.3.6 The shooter may wear additional speed loaders/moon clips behind the hipbone on the weak side or behind the holster.

8.6.3.7 The same exact location for speed loaders, speed loader pouches, moon clips, moon clip pouches, and/or ammunition feeding devices in pockets must be used for every stage in a single match, unless otherwise specified in a stage description.

8.6.4 Speed Loader Carrier Pictures:

Ex. 8.6.3.2 Legal

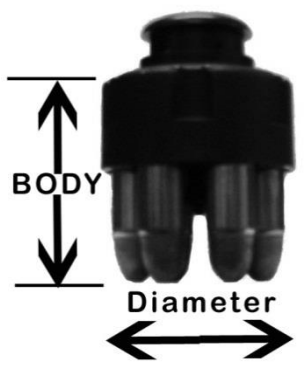

Ex. 8.6.3.2 Legal



Ex. 8.6.3.2 Legal



Ex. 8.6.3.2 Legal



Ex. 8.6.3.2 Legal



8.6.5 Moon Clip Carrier Pictures:

Ex. 8.6.3.3 Legal



Ex. 8.6.3.3 and Ex. 8.6.3.4 Not Legal



8.7 Duty Gear Exemption

- 8.7.1** This duty gear exemption is for patrol type gear worn by uniformed personnel, not under cover, plainclothes, or investigative type gear.
- 8.7.2** Police and military personnel are allowed to use their duty rigs as follows:
- 8.7.3** The duty holster must be a strong side belt or thigh holster with at least one retention feature.
- 8.7.4** All retention features of the holster must be used.
- 8.7.5** All belt equipment holders must be present. The shooter may decide which belt equipment is present.
- 8.7.6** Police and military personnel using the duty gear exemption are exempt from:
 - 8.7.6.1** Using concealment garment.
 - 8.7.6.2** Holster design and placement requirements (other than listed above).
 - 8.7.6.3** Ammunition carrier design and placement requirements.
 - 8.7.6.4** Belt design and placement requirements.
- 8.7.7** Police and military personnel who carry a firearm mounted light and/or laser on duty may compete with a firearm mounted light/laser using their duty holster. The light/laser may not be activated during a string of fire. With the light/laser removed, the firearm must meet all division requirements.
- 8.7.8** The duty gear exemption is for Tier One (1) local club matches only and does not apply at sanctioned matches.

8.8 Miscellaneous

8.8.1 Knee Pads & Elbow Pads

- 8.8.1.1** Hard shell kneepads and elbow pads are not allowed.
- 8.8.1.2** Soft shelled pads, braces, and tape may be worn throughout a match without being concealed, provided they are worn for each stage of the match. Pads, braces, and tape worn under concealment may be put on and removed as the competitor sees fit.

8.8.2 Cleats

Cleated shoes may be worn so long as the cleats are made from a rubber compound that you can push your fingernail into. No hard plastic or metal cleats are permitted.

8.8.3 Gloves

Gloves may be used.

8.8.4 Flash Lights:

- 8.8.4.1** Only hand held lights may be used in IDPA competition. For Physically Disabled shooters, refer to Physically Disabled Shooters Section.
- 8.8.4.2** Lights may not be attached to the shooter's hand, wrist, or arm in any fashion.
- 8.8.4.3** Rings or straps that go around any part of the shooter's body (finger, palm, wrist, etc.) are not allowed.
- 8.8.4.4** Lanyards may be present, but may not be used.
- 8.8.4.5** Police and military personnel using the Duty Gear Exemption with a firearm mounted light may not activate the mounted light, and are otherwise subject to the same hand held flashlight usage rules as other competitors. See rule 3.17..

8.9 Concealment Garments

- 8.9.1** Legal concealment garments hide the holster, firearm, ammunition carriers, and loading devices from view.

- 8.9.2** The concealment garment test is for the competitor to stand with their arms straight out to the side, parallel to the ground. If the standing SO cannot see the previously listed equipment from the front, sides, or rear, then the concealment garment is legal.
- 8.9.3** Concealment garments may not be modified with plastic zip ties, wire, metal, Styrofoam, cardboard, or any similar material that would stiffen the garment or pockets. Patches may not be placed on concealment garment pockets used during a string of fire. Standard laundry starch is acceptable.
- 8.9.4** Weights may not be attached to concealment garments, but items may be placed in pockets. Pocket flaps may be inserted into pockets.
- 8.9.5** Specially made pockets for magazine stowage after a reload may not be used.
- 8.9.6** Lights do not need to be concealed.

09 – Classification Rules

9.0.1

IDPA shooters are divided into six (6) separate Classifications so that shooters may compete against others of like skill. These Classifications are Novice, Marksman, Sharpshooter, Expert, Master, and Distinguished Master. New IDPA members are Unclassified in a division until they shoot their first IDPA Classifier in that Division or receive an Equity Promotion in that division. There are three ways a shooter's classification can change, one by shooting the Classifier, two by being promoted based on performance in a Sanctioned Match, and three by an Equity Promotion.

- 9.0.2** The IDPA Classifier is a ninety (90) round, three (3) stage, fourteen (14) string match that classifies shooters in a short time. Distinguished Master, however, is only attained by winning the Division Champion title or scoring within three percent (3%) of the Division Champion score, at the IDPA U.S. Nationals, IDPA U.S. Indoor Nationals, or the IDPA World Championship.

9.1 Classification Database

- 9.1.1** The IDPA Classification Database is the only official record of Classifications. The IDPA Classification Database must be kept up-to-date and accurate by each IDPA club's Match Director, Club Contact, or designee.
- 9.1.2** When a Classifier Match is held, or a Classification Promotion occurs at a Sanctioned Match, the Club Contact, Match Director, or designee must upload the appropriate scores to the IDPA Classification Database within seven (7) calendar days.

9.2 Classification Frequency

- 9.2.1** Every IDPA member must shoot the Classifier at least once every twelve months, except Master and Distinguished Master class shooters. A Match Performance Promotion in the last twelve months in a Division counts as shooting the IDPA Classifier in that Division. Shooting and completing a Sanctioned IDPA match in the last twelve months (without a DQ or DNF) also counts as shooting a Classifier in the division in which the shooter competed.
- 9.2.2** Should a Match Director feel that a shooter should be shooting in a higher Classification level, the MD may require that the shooter shoot the Classifier again to reestablish a current Classification.
- 9.2.3** Every shooter in a Sanctioned Match must be classified per 9.2.1 within the previous twelve months (365 days/366 days on Leap years,) in the Division in which they are entered. The Match Director or

designee must confirm that the IDPA membership card and Classification in the database are current on match day for every entry in a Sanctioned Match.

9.2.4 For local matches it is sufficient to shoot a Classifier in the Division most often entered. A shooter may compete in club matches in a Division where a Classification is not current within twelve months or the shooter is Unclassified, where the highest Classification ever held in any division will be used.

9.2.5 Shooters may not go down in Classification except for permanent physical disability or for other irrevocable reasons. IDPA HQ will determine when this is appropriate and make the necessary adjustments to the Classification Database.

9.3 One Classifier Score Applied To Multiple Divisions

9.3.1 The score attained by shooting the Classifier can be applied to other divisions where the equipment and ammunition used while shooting the Classifier meets the requirements of those other divisions. The shooter must notify the MD before the Classifier begins of the intent to apply a single score to multiple divisions and the MD must verify that the equipment and ammunition meet the requirements for multiple divisions.

9.3.2 Examples: SSP score also applied to ESP; CDP score shot with SSP compliant equipment and CDP legal ammunition also applied to SSP and ESP.

9.3.3 Classifications attained in this manner are applicable to six firearm awards.

9.4 Match Performance Promotion

9.4.1 Classification can also be affected by a shooter's performance in Sanctioned Matches. This is based on the number of people in a shooter's Division and Classification and the Classifications above within that same Division. This method of Classification promotion calculation does not include DQ's, DNF's or match no-shows.

9.4.2 The winner of a class at a Sanctioned Match will be promoted to the next higher Classification if that shooter beats nine shooters in that class or any higher class in that Division.

9.4.3 The second place finisher of a class at a Sanctioned Match will be promoted to the next higher Classification if that shooter beats 19 shooters in that class or any higher class in that Division. This progression continues for the third, fourth, fifth place, etc. in the match. For example, the fourth place finisher will be promoted if that shooter beats 39 shooters in that class or any higher class in that Division.

9.4.4 If two or more shooters in the same Division and Classification in a match have the exact same score, and that score qualifies for a Classification Promotion, all shooters with that score will be promoted.

9.5 Equity Promotion

9.5.1 A shooter's highest and lowest Classification in a semi-auto division can only differ by one Classification level. When a semi-auto shooter receives a match performance promotion or shoots a classifier, the Equity Promotion rule is applied to all semi-automatic Divisions. Divisions in which the shooter is Unclassified also receive an Equity Promotion by this rule if the highest Classification attained is Marksman or above. The Equity Promotion does not apply to or affect REV or BUG divisions.

9.5.2 For example, if a shooter is promoted to Sharpshooter in a match or shoots a Sharpshooter class score in the Classifier and it is a new highest class, then that Classification is entered into the database. Additionally, the shooter's Classifications in other semi-automatic Divisions below Marksman will be promoted to Marksman. When Expert becomes a shooter's new highest semi-auto class, then any semi-auto Classification below Sharpshooter will increase to Sharpshooter.

9.5.3 Equity Promotions do not count as shooting the Classifier. For Divisions where the shooter’s Equity Promotion applies, it defines the minimum classification that one can shoot under. The shooter still needs to meet the requirements of rule 9.2.3 above for Sanctioned Matches. This rule does not apply to six firearm awards, which may only be attained by shooting Classifiers at the appropriate level.

9.6 REV and BUG Initial Classification

9.6.1 REV

9.6.1.1 A shooter’s initial Revolver (REV) classification is the highest classification previously attained in SSR or ESR. After the initial Classification, the shooter’s Revolver Classifier score, or Revolver Match Promotion determines the Classification in the normal ways shown above.

9.6.2 BUG

9.6.2.1 A shooter’s initial BUG classification is the shooter’s highest Classification attained in any division, minus one level. (Example: if the shooter's highest Classification is Expert, then the shooter's initial BUG Classification is Sharpshooter.) After the initial Classification, the shooter’s BUG Classifier scores, or BUG Match Promotions determine the Classification in the normal ways shown above.

9.7 Classification Scoring Breakdown

Times for:	ESP	SSP	CDP	CCP	REV	BUG
Master (MA)	89.00 or less	91.00 or less	92.00 or less	96.00 or less	102.00 or less	TBD
Expert (EX)	89.01 thru 109.00	91.01 thru 110.00	92.01 thru 111.00	96.01 thru 116.00	102.01 thru 124.00	TBD
Sharpshooter (SS)	109.01 thru 138.00	110.01 thru 140.00	111.01 thru 142.00	116.01 thru 149.00	124.01 thru 158.00	TBD
Marksman (MM)	138.01 thru 190.00	140.01 thru 192.00	142.01 thru 195.00	149.01 thru 204.00	158.01 thru 218.00	TBD
Novice (NV)	190.01 or greater	192.01 or greater	195.01 or greater	204.01 or greater	218.01 or greater	TBD

9.8 The Classifier Match

9.8.1 Only current IDPA-affiliated clubs may run Classifiers and only current IDPA members may shoot the Classifier. New shooters that have applied for IDPA membership, but do not yet have an IDPA number may shoot the Classifier and the results will be held by the Match Director until the shooter receives a membership card.

9.8.2 Only the Match Director and Certified SOs specifically designated by the MD or Club Contact can hold a Classifier match for one person or several squads as needed. However, an MD or SO may not run the Classifier for him/herself. Every IDPA-affiliated club must run the Classifier as one of their monthly matches at least once per year. To accommodate local shooters that want to shoot Sanctioned Matches, holding more than one Classifier per year is recommended.

9.8.3 The Classifier must be shot as a single ninety (90) round match, shot all in one day to the best of one’s ability. It is permissible to allow reshoots of a whole stage due to equipment problems and/or shooter mental errors for the purpose of accurate Classification as long as the reshoot occurs on the same day as

the rest of the Classifier. However, no reshoots of individual strings of fire are permitted. If the Classifier is part of a scored match with other IDPA stages or the shooter is trying to attain a six firearm award, no reshoots are permitted.

9.8.4 During the Classifier only, shooters may load to division capacity, or fully load their normal IDPA compliant magazines, or load to any count sufficient to complete a string as required. The two strings that require downloading must use the exact loading specified.

9.8.5 A concealment garment is optional for the Classifier.

9.8.6 Stage One. Limited Scoring, 7 yards (6.4 meters)

String	Position	Instructions	Shots
1	1	Draw and fire two shots to the body and then one to the head on T1.	3
2	1	Draw and fire two shots to the body and then one to the head on T2.	3
3	1	Draw and fire two shots to the body and then one to the head on T3.	3
4	1	Draw and fire two shots at each head T1-T3 in any order.	6
The Scorekeeper will watch for required head shots that miss the head and hit the body. These hits below the head area must be noted or pasted before shooting String Five.			
5	1	Start with firearm in the weak hand, pointed down range at a 45° down angle, safety may be off, but the trigger finger must be out of trigger guard. Fire one shot each at T1-T3 in any order, weak hand only.	3
6	1	Load exactly 3 rounds in the firearm. Start back to targets, turn, then draw, and fire one shot each at T1-T3 in any order, reload from slide lock or empty cylinder and fire one shot each at T1-T3 in any order.	6
7	1	Draw and fire two shots each at T1-T3 in any order, strong hand only.	6

9.8.7 Stage Two. Limited Scoring, 10 yards and 5 yards (9.1 meters and 4.6 meters)

String	Position	Instructions	Shots
1	2	Draw and fire 2 shots each at T1 - T3 in any order while moving forward. All shots must be fired while moving straight toward T2. There is a forward fault line for this string at the 5-yard line.	6
2	3	Draw and retreat from targets, fire 2 shots each at T1 - T3 in any order while retreating straight backward from T2. All shots must be fired while retreating.	6
3	2	Load exactly 6 rounds in the firearm. Start back to targets, turn, then draw, and fire 2 shots each at T1 - T3 in any order, reload from slide lock or empty cylinder and fire 2 shots each at T1 - T3 in any order.	12
4	2	Draw and fire 2 shots each at T1 - T3 in any order, strong hand only.	6

9.8.8 Stage Three. Limited Scoring, 20 yards and 15 yards (18.3 meters and 13.7 meters)

String	Position	Instructions	Shots
1	4	Draw and fire 2 shots each at T1 - T3 in Tactical Priority from either side of the barricade using cover, do a Loaded Chamber Reload and fire 2 shots each at T1 - T3 in Tactical Priority from the opposite side of the barricade using cover.	12
2	4	Draw and fire 2 shots each at T1 - T3 in Tactical Priority from either side of the barricade using cover, do a Loaded Chamber Reload and advance to the barrel, fire 2 shots each at T1 - T3 in Tactical Priority using low cover shooting around either side of the barrel.	12
3	5	Draw, then kneel, and fire 2 shots each at T1 - T3 in Tactical Priority using low cover shooting around either side of the barrel.	6

9.8.9 The start position for all strings except Stage 1 / String 5 is standing erect with hands naturally at sides.

9.8.10 When shooting around the barrel, the muzzle of the firearm may be higher than the top of the barrel, but the shooter's arms and hands must not be extended over the barrel and shots must not go over the barrel.

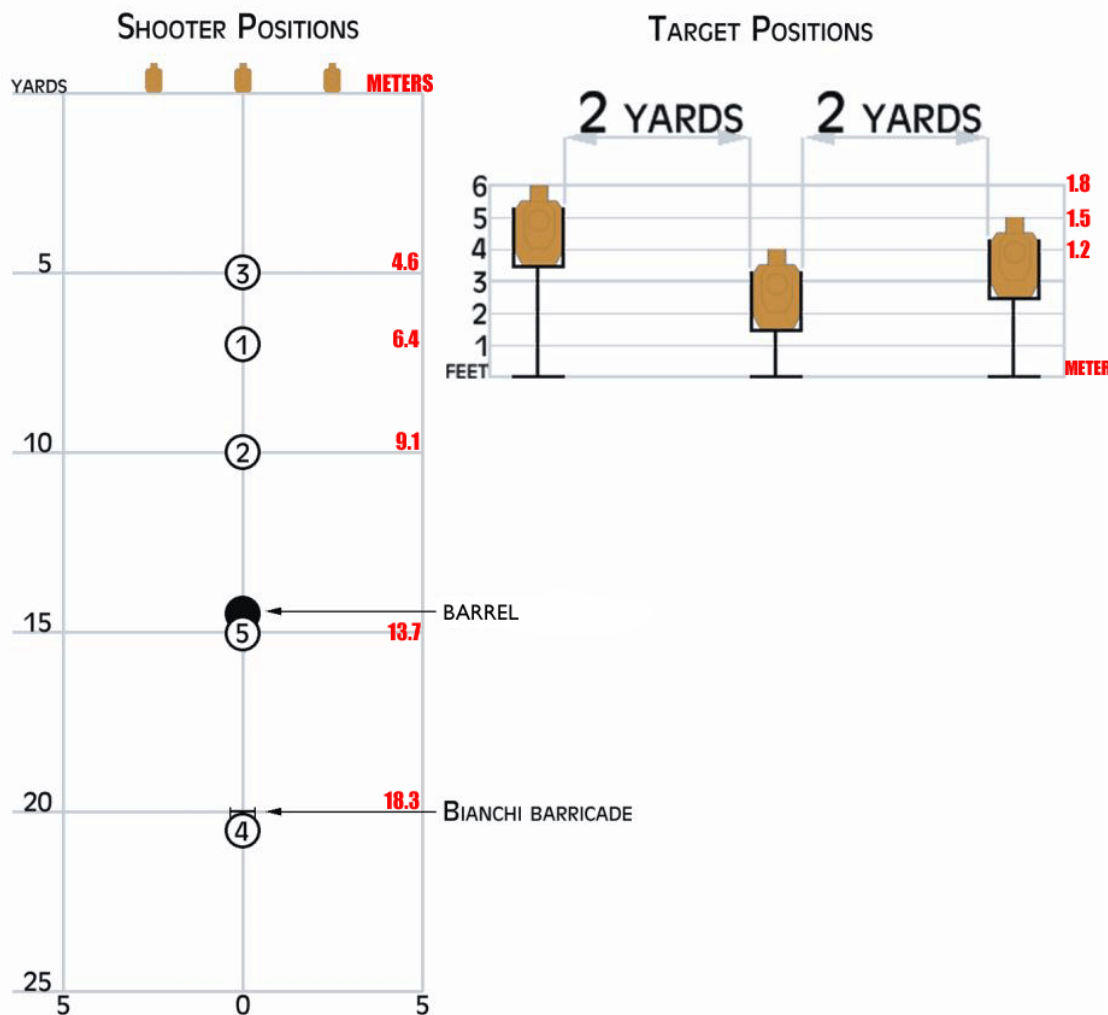

9.8.11 The barrel used in the classifier is approximately 34” tall and 23” in diameter (0.9 meters x 0.6 meters). For ranges where barrels are not allowed a small barricade with the same height and width as a barrel may be used instead.

9.8.12 A Bianchi barricade is 72” tall and 24” wide (1.8 meters x 0.6 meters.)

10 – Appeals Process

10.1 Definition:

The purpose of this process is to provide guidelines, which promote constructive dialogue and resolution of shooter concerns at a sanctioned match. An appeal expresses dissatisfaction with a decision or interpretation of the current IDPA rules as applied by the Match Director, Safety Officers or Stage Designers.

10.2 Scope of this Process:

This process will govern IDPA sanctioned matches only. The IDPA Rules in the most current rulebook will be used as the guide for resolving disputes.

10.3 General Guidelines:

10.3.1 Appeals can be submitted according to the following process.

10.3.2 An appeal can be made for stage design before or after a competitor completes the CoF but must be submitted prior to final scores being posted.

10.4 Appeals Requirements:

10.4.1 Shooter verbally appeals the issue/decision to the Chief Safety Officer (CSO) of the stage on which the dispute arose, adhering to all aspects of the IDPA Shooter’s Code of Conduct, immediately after attempting to shoot the CoF.

10.4.2 If disagreement still exists, Shooter verbally appeals the issue/decision to the Match Director (MD), adhering to all aspects of the IDPA Shooter’s Code of Conduct, within 15 minutes of receiving the decision from the Chief Safety Officer of the bay/stage.

10.4.3 If disagreement still exists, the Shooter shall alert the MD immediately after the MD has ruled of Shooter’s intent to file a written appeal.

10.4.4 Shooter submits a written appeal within 30 minutes of informing Match Director of his intent. The preparation of the document rests solely on the appellant. Appeals received past this time limit will not be considered. The appeal should include the following information:

10.4.4.1 Shooter’s name and contact information (including cell phone number, if applicable)

10.4.4.2 Brief description of the issue (100 words or less)

10.4.4.3 Names of witnesses and description of evidence, if applicable

10.4.4.4 Confirmation that the appeal has been expressed to both the CSO and MD

10.4.4.5 Specific rule and number from the current rulebook (including page number) that has been violated or is being reviewed

10.4.4.6 Specify the desired outcome of the appeal

10.5 A fee of \$100 USD cash must accompany the written appeal.

10.6 Appeals Process:

- 10.6.1** After receipt of the written appeal, the MD will deliver the document to the Area Coordinator of the region (AC) or his delegate, who will act as Lead of the Arbitration Team.
- 10.6.2** The AC will select a team of 3 shooters who are Certified Safety Officers, including himself, to comprise the Appeals Team; each member will have one vote. The Appeals Team Members should have no conflict of interest with the outcome.
- 10.6.3** The Appeals Team will review the document prepared by the Shooter and will retain the appeal fee until a decision is made.
- 10.6.4** The Team may request further information from the shooter, Safety Officer, CSO, MD or witnesses, and may inspect any stage or area related to the appeal.
- 10.6.5** The Shooter filing the appeal should not initiate communications with any of the parties involved with the issue or with the arbitration team after the initial submission of the appeal.
- 10.6.6** The team will deliberate and render a decision within 1 hour after receipt of the appeal. This will be presented to the MD and the shooter who filed the appeal.
- 10.6.7** It is the responsibility of the MD to implement the Committee's decision. If the Team supports the appeal, this may involve reinstating the Shooter, providing the Shooter with a reshoot, eliminating a penalty or withdrawing the stage from the match. If the team does not support the appeal, the decision of the MD stands and the appeal fee will be forwarded by the AC to IDPA Headquarters. If the Committee supports the appeal, the \$100 is returned to the shooter.
- 10.6.8** All decisions by the Team are final and may not be appealed.
- 10.6.9** No Third Party Appeals will be accepted by a shooter on behalf of someone else.
- 10.6.10** The Area Coordinator will provide a summary of the appeal and disposition to IDPA Headquarters within 1 week of the match completion date.

11 – Headquarters Information

2232 CR 719, Berryville, AR 72616

Phone: 870-545-3886 Fax: 870-545-3894

www.idpa.com

Competition and Equipment Rules of the International Defensive
Pistol Association, Inc.,

Copyright © 1996 -2015 International Defensive Pistol Association,
Inc., all rights reserved.

11.1 Club

- 11.1.1** An IDPA affiliated club is a group of shooters who get together to put on IDPA matches. The first impression a new shooter gets of an affiliated club is the first impression that person gets of IDPA.
- 11.1.2** IDPA is unique in that it offers clubs an exciting, competitive format for shooters using truly practical firearms carried in a truly practical way. Financial costs for IDPA clubs are minimal. There are no fees other than the annual affiliation fee. The rules of IDPA are minimal, thereby placing a lesser burden on club officers. The IDPA classification system allows competitors to classify in one day. There are many good CoF templates available on a number of websites. These can be modified to provide more variety.

- 11.1.3** IDPA is a Trophy only Club based sport. Due to the trophy only status of IDPA, a large burden has been taken off the match organizers since they do not have to worry about soliciting cash and merchandise prizes for their events.
- 11.1.4** IDPA headquarters will refer all interested parties in your state to your club. Your club information will be posted on the IDPA website at www.idpa.com. Clubs are allowed to retain \$5 of IDPA membership fees for every new member the club signs up (Please make sure new members sign the front of the membership application, the waiver and have a witness sign the waiver, otherwise HQ will send the membership application back to you). This pertains to new members only and does not include renewing members.
- 11.1.5** Some countries have laws that prohibit concealed carry and self-defense; therefore, those interested in shooting or organizing IDPA competitions in these countries face unique problems. Due to this unfortunate political situation, IDPA authorizes the clubs in these countries to modify the name of the organization, logo and/or rules to meet local legal requirements. However, no Championship Matches will be “sanctioned” in any country where the competition cannot be run 100% under IDPA rules.

11.2 Requirements for Club Affiliation

- 11.2.1** Match director/club contact personnel must be current IDPA members.
- 11.2.2** Match director/club contact personnel must be certified IDPA Safety Officers.
- 11.2.3** Club matches and facilities must be open to all IDPA members.
- 11.2.4** Clubs must run the IDPA Classification Match as one of their monthly matches at least once each year. IDPA HQ suggests that the classifier be shot as soon as possible and be available to classify new shooters four (4) times a year.
- 11.2.5** Clubs must agree to hold a minimum of six (6) IDPA matches per year.
- 11.2.6** At club level events, competitors may shoot in all divisions.
- 11.2.7** Clubs must follow IDPA rules and principles.
- 11.2.8** Clubs must make sure the competitors have the benefit of the doubt in all questionable circumstances.
- 11.2.9** Most importantly--Have fun!

11.3 Headquarters (HQ)

IDPA Headquarters is located at 2232 CR 719, Berryville, AR, 72616 HQ maintains records of all members, sends out membership cards, takes care of all pro shop orders, handles any questions any members may have, produces the Tactical Journal (the quarterly publication for members), makes certificates and cards for Safety Officers, etc. All decisions that come from HQ are based on what is best for the individual member, the club and the sport.

11.4 Logo Policy

The International Defensive Pistol Association logo is trademarked private property of the International Defensive Pistol Association, Inc. It is not available for individual commercial use. However, currently affiliated clubs may use the logo on match announcements, correspondence or on event commemorative clothing such as hats and tee shirts. Electronic and hard copy versions are available from IDPA HQ.

11.5 Insurance Information

At this time, IDPA does not offer a club liability insurance program. We recommend that you contact the NRA for possible information.



2232 CR 719, Berryville, AR 72616

Phone: 870-545-3886 Fax: 870-545-3894

www.idpa.com

Match Administration Rules of the International Defensive
Pistol Association, Inc., adopted 10/26/96, effective 3/1/2015.
Copyright © 1996 -2015 International Defensive Pistol Association,
Inc., all rights reserved
V1.0

01 - Match Administration Handbook

The following information pertains to the administration of IDPA matches and is intended for the member who wishes to become a Safety Officer, Match Director or Area Coordinator.

This is supplemental to the IDPA Rulebook.

1.1 Match Rules

- 1.1.1** All IDPA rules must be followed for every match at every tier.
- 1.1.2** Safe areas, as defined in section 2.10, are required at all matches.
- 1.1.3** Shooters will only be allowed to shoot in one (1) division in matches tier two and higher.
- 1.1.4** Other than tier one (1), official IDPA score sheets printed on NCR paper in duplicate will be used in the match if paper score sheets are used to enter scores. If scoring is done electronically, the shooter must receive a paper copy of each stage score.
- 1.1.5** The approved CoF and sanctioned match application with the sanction fee for tier two (2) and higher matches must be sent to IDPA headquarters by the Area Coordinator at least sixty (60) days before match date including the AC design aid form. (The sanctioning process and pricing information is located on www.idpa.com.)
 - 1.1.5.1** All “named” matches like state, regional, etc., other than a club’s local matches must be Sanctioned matches.
 - 1.1.5.2** MDs are responsible for knowing what other matches have been sanctioned in the same geographic area within the same time period that may compete with the match they are scheduling.
 - 1.1.6** The Match Director must have taken a Safety Officer course from an IDPA Safety Officer Instructor and must be currently certified.
- 1.1.7** If an Area Coordinator is also the Match Director, then the stages must be approved by another Area Coordinator or IDPA Headquarters.
- 1.1.8** Scores are final and cannot change after the one (1) hour protest period at the end of a match.
- 1.1.9** Video may not be used to determine a shooter’s score.
- 1.1.10** All competitors in a Specialty match will earn one (1) Nationals match point. HQ must approve Specialty Sanctioned matches as defined in Match Administration 1.2.2.

- 1.1.11** Ties shall be broken in a manner decided upon by the match director conducting the contest, however, this shall always be done by shooting, not by chance. All tied shooters will qualify for a match class promotion (bump) if applicable.
- 1.1.12** All competitors at a Tier two (2) or higher match must be able to view the match stages before their scheduled shooting session. Shooters will not be allowed within the stage bay rear limit as denoted by the Match Director by the use of “caution tape,” fencing or another suitable visual indicator.

1.2 Match Administration Rules

1.2.1 Match Tiers - Matches will be categorized by tiers, with a local monthly club match being tier one (1) and a national level match being tier five (5).

1.2.1.1 Tier One (1) Matches (Local club match)

1.2.1.1.1 A Chief Safety Officer is recommended. A Chief Safety Officer is appointed by the Match Director as the Safety Officer running the stage or squad, the qualifications of whom, are listed under Safety Officer Roles and Responsibilities.

1.2.1.1.2 A Chief Safety Officer per squad, per two stages, or per bay is recommended.

1.2.1.1.3 Stages are approved by the Match Director.

1.2.1.1.4 Equipment checks are recommended.

1.2.1.1.5 Competitors must be IDPA members after their first match.

1.2.1.1.6 Competitors having a current classification in the division in which they are competing is recommended.

1.2.1.1.7 Recognizing all regular divisions and BUG is required. NFC is optional.

1.2.1.1.8 All classes must be recognized.

1.2.1.1.9 Any special range safety rules should be posted at registration. (i.e. no high muzzles during reloads, etc.)

1.2.1.1.10 Open squads (shotgun squads) are permitted.

1.2.1.2 Tier Two (2) Matches (Sanctioned)

1.2.1.2.1 Must be able to accommodate at least 75 competitors, including staff.

1.2.1.2.2 Minimum number of stages is 8.

1.2.1.2.3 Minimum round count is 100.

1.2.1.2.4 At least one standard stage is recommended.

1.2.1.2.5 Standards stage round count must not exceed 20% of the total round count.

1.2.1.2.6 A Chief Safety Officer per two stages, or per bay is required. A Chief Safety Officer is appointed by the Match Director as the Safety Officer running the stage or squad, the qualifications of whom, are listed under Safety Officer Roles and Responsibilities

1.2.1.2.7 Certified Safety Officers are required.

1.2.1.2.8 At least one (1) Certified Safety Officer per bay is required.

1.2.1.2.9 Stages are approved by the Area Coordinator.

1.2.1.2.10 Dual score entry is recommended for paper score sheets.

1.2.1.2.11 Legible shooting session scores must be posted within one hour of the session end. If shooters will not be present when the final scores are posted, the scores for each session must be posted to allow shooters to check their scores.

1.2.1.2.12 Chronographing competitor ammunition is recommended.

1.2.1.2.13 Equipment checks are recommended.

1.2.1.2.14 Competitors must be IDPA members.

- 1.2.1.2.15 Competitors must have a current classification in the division in which they are competing.
- 1.2.1.2.16 Classification promotions must be entered into the on-line Classification database at IDPA headquarters within one week of the match completion.
- 1.2.1.2.17 Recognizing all regular divisions is required. BUG is optional.
- 1.2.1.2.18 Recognizing novice class is recommended, while Marksman and above is required.
- 1.2.1.2.19 The Area Coordinator or their designate must be offered entry to the match at no charge.
- 1.2.1.2.20 Any special range safety rules must be posted on the web site registration page or printed on the registration form. (i.e. no high muzzles during reloads, etc.)
- 1.2.1.2.21 Open squads (shotgun squads) are permitted.
- 1.2.1.2.22 All competitors in the match will earn one (1) Nationals match point.

1.2.1.3 Tier Three (3) Matches (Sanctioned)

- 1.2.1.3.1 Must be able to accommodate at least 125 competitors, including staff.
- 1.2.1.3.2 Minimum number of stages is 10.
- 1.2.1.3.3 Minimum round count is 125.
- 1.2.1.3.4 At least one standard stage is required.
- 1.2.1.3.5 Standards stage round count must not exceed 20% of the total round count.
- 1.2.1.3.6 A Squad Safety Officer is recommended. A Squad Safety Officer travels with a squad of shooters to assist in administering the squad through the match.
- 1.2.1.3.7 A Chief Safety Officer per two stages, or per bay is required. A Chief Safety Officer is appointed by the Match Director as the Safety Officer running the stage or squad, the qualifications of whom, are listed under Safety Officer Roles and Responsibilities
- 1.2.1.3.8 A tier three (3) Chief Safety Officer must have at least two years' experience and have officiated at least one prior tier two or higher match.
- 1.2.1.3.9 Certified Safety Officers are required.
- 1.2.1.3.10 At least two (2) Certified Safety Officers per bay are required.
- 1.2.1.3.11 Stages are approved by the Area Coordinator.
- 1.2.1.3.12 Dual score entry is recommended for paper score sheets.
- 1.2.1.3.13 Legible shooting session scores must be posted within one hour of the session end. If shooters will not be present when the final scores are posted, the scores for each session must be posted to allow shooters to check their scores.
- 1.2.1.3.14 Chronographing competitor ammunition is required.
- 1.2.1.3.15 Equipment checks are required. Equipment checks include ensuring the gun is within weight limits and fits in the IDPA gun test box as specified in the Equipment Rules section. Proper placement and design of ammunition carriers and holsters must also be checked.
- 1.2.1.3.16 Competitors must be IDPA members.
- 1.2.1.3.17 Competitors must have a current classification in the division in which they are competing.
- 1.2.1.3.18 Classification promotions must be entered into the on-line Classification database at IDPA headquarters within one week of the match completion.
- 1.2.1.3.19 Recognizing all regular divisions is required. BUG is optional.
- 1.2.1.3.20 Recognizing all classes other than Novice is required.
- 1.2.1.3.21 The Area Coordinator must be offered entry to the match at no charge.
- 1.2.1.3.22 Any special range safety rules must be posted on the web site registration page or printed on the registration form. (i.e. no high muzzles during reloads, etc.)

1.2.1.3.23 Squadding shooters is recommended at this level. Open Squadding has to be noted in the registration information.

1.2.1.3.24 All competitors in the match will earn two (2) Nationals match points.

1.2.1.4 Tier Four (4) Matches (Sanctioned)

1.2.1.4.1 Must be able to accommodate at least 200 competitors, including staff.

1.2.1.4.2 Minimum number of stages is 12.

1.2.1.4.3 Minimum round count is 150.

1.2.1.4.4 At least one standard stage is required.

1.2.1.4.5 Standards stage round count must not exceed 20% of the total round count.

1.2.1.4.6 A Squad Safety Officer is recommended. A Squad Safety Officer travels with a squad of shooters to assist in administering the squad through the match.

1.2.1.4.7 A Chief Safety Officer per two stages, or per bay is required. A Chief Safety Officer is appointed by the Match Director as the Safety Officer running the stage or squad, the qualifications of whom are listed under Safety Officer Roles and Responsibilities.

1.2.1.4.8 A tier four (4) Chief Safety Officer must have at least three years' experience and have officiated at least two prior tier two or higher matches.

1.2.1.4.9 Certified Safety Officers are required.

1.2.1.4.10 At least two (2) Certified Safety Officers per bay are required.

1.2.1.4.11 Stages are approved by the Area Coordinators and IDPA HQ.

1.2.1.4.12 Dual score entry is required for paper score sheets.

1.2.1.4.13 Legible shooting session scores must be posted within one hour of the session end. If shooters will not be present when the final scores are posted, the scores for each session must be posted to allow shooters to check their scores.

1.2.1.4.14 Chronographing competitor ammunition is required.

1.2.1.4.15 Equipment checks are required. Equipment checks include ensuring the gun is within weight limits and fits in the IDPA gun test box as specified in the Equipment Rules section. Proper placement and design of ammunition carriers and holsters must also be checked.

1.2.1.4.16 Competitors must be IDPA members.

1.2.1.4.17 Competitors must have a current classification in the division in which they are competing.

1.2.1.4.18 Classification promotions must be entered into the on-line Classification database at IDPA headquarters within one week of the match completion.

1.2.1.4.19 Recognizing all regular divisions is required. BUG is optional.

1.2.1.4.20 Recognizing all classes other than Novice is required.

1.2.1.4.21 The Area Coordinator or designate must be offered entry to the match at no charge.

1.2.1.4.22 Any special range safety rules must be posted on the web site registration page or printed on the registration form. (i.e. no high muzzles during reloads, etc.)

1.2.1.4.23 Open squads (shotgun squads) are not permitted.

1.2.1.4.24 All competitors in the match will earn three (3) Nationals match points.

1.2.1.5 Tier Five (5) Matches (Sanctioned)

1.2.1.5.1 Only include the US National Championship, Indoor National Championship and World Championships

1.2.1.5.2 Must be able to accommodate at least 250 competitors, including staff.

1.2.1.5.3 At least one standard stage is required.

1.2.1.5.4 Standards stage round count must not exceed 20% of the total round count.

- 1.2.1.5.5** A Squad Safety Officer is recommended. A Squad Safety Officer travels with a squad of shooters to assist in administering the squad through the match.
- 1.2.1.5.6** A Chief Safety Officer per two stages, or per bay is required. A Chief Safety Officer is appointed by the Match Director as the Safety Officer running the stage or squad, the qualifications of whom are listed under Safety Officer Roles and Responsibilities.
- 1.2.1.5.7** A tier five (5) Chief Safety Officer must have at least three years' experience and have officiated at least three prior tier two or higher matches.
- 1.2.1.5.8** Certified Safety Officers are required.
- 1.2.1.5.9** At least two (2) Certified Safety Officers per bay are required.
- 1.2.1.5.10** Stages are approved by the IDPA headquarters CoF approval board.
- 1.2.1.5.11** Dual score entry is required for paper score sheets.
- 1.2.1.5.12** Legible shooting session scores must be posted within one hour of the session end. If shooters will not be present when the final scores are posted, the scores for each session must be posted to allow shooters to check their scores.
- 1.2.1.5.13** Chronographing competitor ammunition is required.
- 1.2.1.5.14** Equipment checks are required. Equipment checks include ensuring the gun is within weight limits and fits in the IDPA gun test box as specified in the Equipment Rules section. Proper placement and design of ammunition carriers and holsters must also be checked.
- 1.2.1.5.15** Competitors must be IDPA members.
- 1.2.1.5.16** Competitors must have a current classification in the division in which they are competing.
- 1.2.1.5.17** Classification promotions must be entered into the on-line Classification database at IDPA headquarters within one week of the match completion.
- 1.2.1.5.18** Recognizing all regular divisions is required. BUG is optional.
- 1.2.1.5.19** Recognizing all classes other than Novice is required.
- 1.2.1.5.20** Any special range safety rules must be posted on the web site registration page or printed on the registration form. (i.e. no high muzzles during reloads)
- 1.2.1.5.21** Open squads (shotgun squads) are not permitted.
- 1.2.1.5.22** All competitors in the match will earn four (4) Nationals match points.
- 1.2.1.5.23** The Match Director(s) will earn a free slot to the following year's Nationals.
- 1.2.1.5.24** The Match Director(s) must not shoot the match for score.

1.2.2 Specialty Matches

Specialty matches, such as Revolver only, BUG only, women only, a single manufacturer only match, etc., may be approved as a Sanctioned match by IDPA headquarters. All competitors in a Specialty match will earn one (1) Nationals match point.

1.2.3 Awards

At Tier two (2) and higher matches, awards will be given based on number of contestants per class and division (including DQs and DNFs, but not including no-shows) and go to the top one-fifth of those competitors. Tier two and higher matches will provide one award for 1 to 5 entrants, two awards for 6 to 10 entrants, three awards for 11 to 15 entrants, four awards for 16 to 20 entrants, etc.

1.2.3.1 Tier two and higher matches must give trophies or plaques for the Division Champions as well as 1st, 2nd, and 3rd placements, if there are enough entrants to warrant these awards based on the one-fifth rule above. The remaining awards (4th place and on, and subcategories) may be medals or medallions, etc., when there are enough entrants to warrant them based on the one-fifth rule above. See the exception noted in rule 1.2.3.3.

Example:	1-5 shooters in ESP/MM = 1 st award.
	6-10 shooters in ESP/MM = 1 st and 2 nd awards.
	11-15 shooters in ESP/MM = 1 st , 2 nd and 3 rd awards.
	16-20 shooters in ESP/MM = 1 st , 2 nd , 3 rd and 4 th awards, etc.

1.2.3.2 For Tier two and higher matches the MD may choose to give more trophies and/or awards by awarding the top one-fourth or top one-third of shooters, however every division must use the same ratio.

1.2.3.3 The Division Champion in a division is also the first place finisher in the DC's classification. The 1st place trophy in the DC's class will not be awarded.

1.2.4 Subcategories

Subcategories may be recognized at tier one (1) matches, but are required at tier two (2) and higher matches. Subcategories include:

1.2.4.1 High Lady

1.2.4.2 High Junior (ages 12 to 17)

1.2.4.3 High Senior (ages 50 to 64)

1.2.4.4 High Distinguished Senior (ages 65 and older)

1.2.4.5 High Industry - a competitor employed in the firearms or firearms accessory industry, must receive a W-2 or 1099 form or equivalent.

1.2.4.6 High Press - a competitor employed for a print newspaper, print magazine, radio or television production, and must receive a W-2 or 1099 form or equivalent.

1.2.4.7 High International – a competitor living full time in a country other than the country in which the match is held

1.2.4.8 High Military - a person who is, or has honorably served in the Armed Forces of his/her country of residence.

1.2.4.9 High Law Enforcement - active or retired law enforcement officer

1.2.4.10 Most Accurate - Person with the lowest points down and no HNT penalties.

1.2.4.11 On the day of the match, your age determines the category:

Junior Member (12th birthday through 17 years of age)

Typical Member (18th birthday through 49 years of age)

Senior Member (50th birthday through 64 years of age)

Distinguished Senior Member (65th birthday and older)

1.2.4.12 18-21 year old shooters may shoot a match without a parent or guardian present, if allowable based on range policies, federal, state, and local law.

1.2.4.13 Junior members must have a parent or guardian present with the shooter at every stage.

1.2.4.14 The Match Director may require proof of competitors being eligible for a subcategory.

1.2.4.15 Clubs are encouraged to come up with other relevant subcategories.

1.2.5 Prizes

Any merchandise donated or purchased for use as prizes will be distributed randomly. Prizes must not be given away based on the match results or in any manner that is based, even in part, on the competitor's score. Side matches are exempt from this rule. **IDPA DOES NOT ENDORSE NOR APPROVE** any type of incentive program based on shooter performance.

1.2.6 Firearm Test Boxes

1.2.6.1 The IDPA firearm test box has an allowed dimensional tolerance of -0" and +¹/₁₆" (1.6 mm.) Boxes outside this tolerance range may not be used in IDPA matches for equipment checks or for "firearm in the box" starts.

Example of tolerance: The width of an SSP, ESP, CCP and CDP gun test box is nominally 8 3/4" but can range from 8 3/4" to 8 13/16" (222.3 mm to 223.8 mm) in width.

- 1.2.6.2** The firearm must be fully assembled, magazine inserted and slide in battery or cylinder closed, must fully fit into the box with the lid shut. An adjustable rear sight may be compressed to fit into the box, and the lid may be held shut with light pressure, but not enough force to flex a part on the firearm, flex the box or the lid, or indent the box or lid material.

1.3 Match Director Roles & Responsibilities

1.3.1 IDPA Match Directors

1.3.1.1 Match Directors are IDPA volunteers whose goal and purpose is to see that all shooters have a safe and enjoyable IDPA match experience by supervising and directing the shooters and match staff through the match.

1.3.1.2 Match Directors perform two vital roles in IDPA:

1.3.1.2.1 Ambassador - Since the Match Director is the master of ceremonies and introductory speaker at an IDPA match; the MD serves as an ambassador for the sport and will be key in forming a new shooter's first impressions of what IDPA is all about.

1.3.1.2.2 Match Official - MDs are the IDPA match officials responsible for efficiently running IDPA matches in accordance with all IDPA rules.

1.3.2 IDPA Match Director Qualifications

1.3.2.1 All IDPA Match Directors must meet the following requirements:

1.3.2.1.1 Must have completed an IDPA Safety Officer Class taught by an authorized IDPA Safety Officer Instructor (SOI) and be designated as a certified SO by IDPA HQ.

1.3.2.1.2 Must maintain their SO certification via continuing SO education and biennial SO recertification requirements in accordance with current IDPA HQ policy. Additionally, it is recommended that MDs are certified CSOs.

1.3.2.1.2.1 MDs for Tier Two (2) and Tier Three (3) matches must be approved by the AC.

1.3.2.1.2.2 MDs for Tier Four (4) and Tier Five (5) matches must be approved by IDPA HQ.

Additionally the MD must have served as a certified CSO in a sanctioned match at least once.

1.3.2.1.3 Must be a current IDPA member in good standing and never have had their membership revoked.

1.3.2.1.4 Must have shot at least six IDPA matches. Newly affiliated IDPA clubs have a six month grace period for Tier One matches.

1.3.2.1.5 Must possess the necessary temperament, attitude and IDPA rulebook knowledge to rationally and successfully resolve shooter/SO/CSO disagreements.

1.3.3 Match Director Responsibilities

The responsibilities of IDPA Match Directors are described below. These responsibilities outline the basic requirements for conducting an IDPA match.

1.3.3.1 IDPA Ambassador

1.3.3.1.1 Represent IDPA professionally and respectfully on and off the range.

1.3.3.1.2 Respect and support IDPA and other shooting sports, IDPA rules, shooters, and spectators.

1.3.3.1.3 Always be friendly and approachable.

1.3.3.1.4 Go out of your way to welcome new shooters, veteran shooters, and spectators alike.

1.3.3.2 IDPA Match Official

1.3.3.2.1 Adhere to the IDPA Match Director Code of Conduct.

1.3.3.2.2 Work as a team with the match staff to help the match run efficiently.

1.3.3.2.3 Enforce IDPA safe gun handling rules by all shooters.

1.3.3.2.4 Ensure individuals on the range are wearing eye and ear protection, when appropriate.

- 1.3.3.2.5 Help the shooters to safely complete and enjoy the match:
- 1.3.3.2.6 Treat the shooters with courtesy and respect.
- 1.3.3.2.7 Verify that the shooter's equipment is IDPA-legal and correctly worn.
- 1.3.3.2.8 Avoid interfering with the shooter's execution of the CoF, unless necessary to maintain a safe shooting environment.
- 1.3.3.2.9 Know and consistently enforce the IDPA rules to ensure that the match is conducted in a fair and impartial manner
 - 1.3.3.2.9.1 Be well versed in the IDPA rule book and be able to explain the rules and their application.
 - 1.3.3.2.9.2 Maintain a fair, impartial manner toward all competitors.
 - 1.3.3.2.9.3 If there is reasonable doubt, the benefit of the doubt goes to the shooter.
 - 1.3.3.2.9.4 Ensure all penalties are called correctly and consistently.
 - 1.3.3.2.9.5 Be available should any additional consultation or appeal be required concerning the behavior of any shooter and any scoring or penalty decisions.
 - 1.3.3.2.9.6 Ensure that the stages are consistent for all shooters.
 - 1.3.3.2.9.7 Ensure that the scenarios are always defensive in nature.
 - 1.3.3.2.9.8 Confirm to the Area Coordinator that all SOs in a match are certified SOs in accordance with the requirements governing the match tier.
 - 1.3.3.2.9.9 Will facilitate the convening of an Appeals Committee in accordance with the current IDPA rulebook.

1.3.4 – Match Director Code of Conduct

- 1.3.4.1 I understand that it is a privilege, and not a right, to be an IDPA Match Director.
- 1.3.4.2 I will follow all of the safety rules of IDPA and the host range.
- 1.3.4.3 I recognize that it is my responsibility to maintain a thorough knowledge of the current IDPA rulebook.
- 1.3.4.4 Prior to and during the match, I will refrain from the use of alcohol, substances, or medications that may negatively impact my ability to perform the duties of a Match Director.
- 1.3.4.5 I will not communicate with others or physically contact others, in a threatening, harassing or abusive manner.
- 1.3.4.6 I will treat all shooters and match staff with respect.
- 1.3.4.7 I will be firm and fair in all judgment calls in the application of the IDPA rules. I will be prepared to state in a clear and concise manner my reasons for such calls to the shooter or any IDPA Official.
- 1.3.4.8 It is my duty to assist, to the best of my ability, all shooters and match staff and not hinder them through harassment or authoritarian behavior.
- 1.3.4.9 I will represent my sport in a professional manner through my behavior and dress, and will represent the standard expected of the match staff.
- 1.3.4.10 The integrity of the Match Director community should never be in doubt. I will refrain from any actions that could cause my honesty or objectivity to be questioned.
- 1.3.4.11 As a representative of IDPA, I will refrain from disparagement or inappropriate criticism of IDPA or other shooting sports, their officials, and rules of match competition.
- 1.3.4.12 I will always be a champion for IDPA and promote IDPA in the best light possible.
- 1.3.4.13 I understand that violations of this code of conduct may result in my removal or disqualification from a match, loss of my privileges as an IDPA Match Director, and/or revocation of my IDPA membership.

1.4 Match Equipment Check Guidelines

1.4.1 Non-IDPA-Legal Modifications

- 1.4.1.1** Check for compensators and ports
 - 1.4.1.2** Check for add on weights
 - 1.4.1.3** Check the guide rod material
 - 1.4.1.4** Check for metal magazine gap plugs and brass magazine wells
 - 1.4.1.5** Check the grip material
 - 1.4.1.6** Barrels longer than 4.25" (108 mm) must not be heavy or cone style.
 - 1.4.1.7** Sights must be conventional post and notch.
 - 1.4.1.8** Lock the slide back and check for a firing pin block. If present, push the firing pin/striker forward and ensure that it does not protrude past the breech face.
 - 1.4.1.9** Ensure that the hammer/striker does not move without depressing the grip safety.
 - 1.4.1.10** Check proper operation of the thumb safety.
 - 1.4.1.11** Check for rail and trigger guard mounted lights and lasers.
 - 1.4.1.12** Check that the SSP, ESP, CCP, CDP, and BUG-S firearms, with the largest magazine inserted or BUG-R cylinder closed, fit in the appropriate sized IDPA box.
 - 1.4.1.13** Check that the gun and the heaviest magazine do not weigh over the division weight limit. The scale used must be able to weigh a test weight twice with a deviation from true weight of no greater than 0.2 ounces (5.7 grams.) A check weight of 1000 grams or 2 pounds is recommended.
 - 1.4.1.14** Check that the gun does not have any modifications from the division excluded modifications and that any other modifications meet the requirements of the division permitted modifications.
- 1.4.2.** Clubs should strive to offer a courtesy equipment check prior to the match start or the shooter's first CoF.
- 1.4.3** Shooter's whose equipment fails to meet the standards in the division they are registered for, will be allowed to shoot for no score and will receive a DNF providing there were no safety issues with the firearm.

1.5 Ammunition Power Factor

Collect seven (7) cartridges from each competitor for chronographing. Conduct the official chronograph procedure for each competitor's ammunition.

1.6 Belts, Holsters, Ammunition Carriers and Concealment garments

Check that belts, holsters, ammunition carriers and concealment garments meet the requirements of the equipment section rules using the listed test methods. It is highly recommended that an inspection be done on the first stage of the day before first shots are fired.

02 – Safety Officer Roles & Responsibilities

2.1 IDPA Safety Officer Description

Certified Safety Officers are IDPA volunteers whose goal and purpose is to see that all shooters have a safe and enjoyable IDPA match experience by supervising and directing the shooter through each match Course of Fire. Safety Officers perform two vital roles in IDPA:

- 2.1.1** Ambassador – Since the Safety Officer is the primary and most visible point of contact for shooters at an IDPA match, the SO serves as an ambassador for the sport and will be the key element in forming a new shooter’s first and ongoing impressions of what IDPA is all about.
- 2.1.2** Match Official - SOs are the IDPA match officials responsible for running shooters through each match CoF. In this role, IDPA SOs work as a minimum two-person team, consisting of a Primary SO (PSO) and a Scorekeeper SO (SSO), each with joint and individual responsibilities. On any CoF, one SO must be designated as the Chief Safety Officer (CSO) for that CoF. The CSO serves as the lead SO for the CoF, and is responsible to the Match Director for the efficient flow of the CoF in accordance with IDPA rules. In larger sanctioned matches, the responsibilities of the CSO, PSO, and SSO may be distributed among a team of three or more SOs to improve match flow and organization.

2.2 IDPA Safety Officer Qualifications

2.2.1 All certified IDPA Safety Officers must meet the following requirements:

- 2.2.1.1** Have completed an IDPA Safety Officer Class taught by an authorized IDPA Safety Officer Instructor (SOI).
 - 2.2.1.2** Be a current member in good standing of IDPA, and not have had their membership revoked.
 - 2.2.1.3** Adhere to the IDPA Safety Officer Code of Conduct.
 - 2.2.1.4** Regularly participate in IDPA matches as an SO at either the club or sanctioned match level.
 - 2.2.1.5** Maintain their SO certification via continuing SO education and recertification every two years in accordance with current IDPA HQ policy.
- 2.2.2** IDPA members wishing to apply to take the IDPA Safety Officer Class should meet the following minimum qualifications to be considered:
- 2.2.2.1** Be at least 21 years of age and be able to lawfully possess a firearm under the laws of your country of residence.
 - 2.2.2.2** Be a current IDPA member in good standing for at least six months, and never have had their membership revoked.
 - 2.2.2.3** Have shot at least six IDPA matches, at the club or sanctioned level.
 - 2.2.2.4** Be willing and able to demonstrate a basic knowledge of the IDPA rulebook.
 - 2.2.2.5** Be sponsored by an IDPA-affiliated club representative that can confirm the applicant’s ability to safely handle a firearm and who is willing and able to provide designated mentor SOs committed to training the graduate SO.
 - 2.2.2.6** Discretion on the part of the IDPA SOI in approving SO Class applicants is permitted to meet the needs of new IDPA start-up clubs and other special situations.
- 2.2.3** It is recommended that SOs designated as CSOs in Tier 1 and Tier 2 sanctioned match CoFs (as defined in match administration) meet the following additional qualifications:
- 2.2.3.1** Have been certified as an IDPA SO for a minimum of one year.
 - 2.2.3.2** Previously served as a SO in at least two sanctioned IDPA matches.

- 2.2.3.3 Possess the necessary temperament, attitude and IDPA rulebook knowledge to rationally and successfully resolve shooter/SO disagreements.
- 2.2.3.4 Please refer to the Match Administration section for details of the specific qualifications required for the position of CSO in Tier 3 and higher matches.
- 2.2.4 It is required that SOs designated as Chief SOs in Tier 3 and above sanctioned matches (as defined above) meet the following additional qualifications:
 - 2.2.4.1 Have been certified as an IDPA SO for a minimum of two (2) years.
 - 2.2.4.2 Have previously served as a Certified SO in at least two (2) sanctioned IDPA matches and participated as a competitor in at least one (1) additional sanctioned match, in the previous three (3) years.
- OR
- 2.2.4.3 Served as a Certified SO in at least three (3) sanctioned IDPA matches in the previous three (3) years.

2.3 Safety Officer Responsibilities

- 2.3.1 The responsibilities of IDPA SOs in each of their roles are described below. These responsibilities outline the basic requirements for safely conducting an IDPA CoF. The allocation of these responsibilities to individual SOs may vary based on the size of the match, the range facility on which the match is held, and the number of SOs assigned to the CoF.
- 2.3.2 The selection and assignment of SOs in a given match is the responsibility of the MD or his designate, in accordance with IDPA Match Administration policies. Significant discretion and flexibility on the part of the MD in developing a match SO organizational structure is expected and encouraged. However, the MD is ultimately responsible to ensure that the selected structure fully allocates these responsibilities to the individual SOs who are accountable for executing them.
- 2.3.3 IDPA Ambassador
 - 2.3.3.1 Represent IDPA professionally and respectfully on and off the range.
 - 2.3.3.2 Respect and support IDPA and other shooting sports, IDPA rules, shooters, and spectators.
 - 2.3.3.3 Always be friendly and approachable.
 - 2.3.3.4 Go out of your way to welcome new shooters, veteran shooters, and spectators alike.

2.4 IDPA Match Official (Joint Safety Officer Responsibilities)

- 2.4.1 Adhere to the IDPA Safety Officer Code of Conduct.
- 2.4.2 Work as a team to ensure the CoF runs efficiently.
- 2.4.3 Help the shooter to complete the CoF safely and enjoy the match:
 - 2.4.3.1 Treat the shooter with courtesy and respect.
 - 2.4.3.2 Verify that the shooter's equipment is IDPA-legal and correctly worn.
 - 2.4.3.3 Verify the shooter is in the correct starting position for the CoF (e.g., hands up, hands down, cover garment on/off, etc.).
 - 2.4.3.4 Address the shooter using correct and concise range commands.
 - 2.4.3.5 Avoid interfering with the shooter's execution of the CoF, unless necessary to maintain a safe shooting environment.
 - 2.4.3.6 To maintain safety, always assist the shooter when necessary and appropriate. However, coaching of the shooter by the SO is not permitted at sanctioned matches.
- 2.4.4 Know and consistently enforce the IDPA rules to ensure that the match is conducted in a fair and impartial manner

- 2.4.4.1 Be an IDPA Rules expert, able to explain the rules and their application.
- 2.4.4.2 Use proper IDPA range commands.
- 2.4.4.3 Maintain a fair, impartial manner toward all competitors.
- 2.4.4.4 If the SO has a reasonable doubt, the benefit of the doubt goes to the shooter.
- 2.4.4.5 Call all penalties correctly and consistently.
- 2.4.4.6 The SO team (PSO and SSO) should assess any penalties and inform the shooter of the penalties incurred. Should any additional consultation or appeal be required, the SO team will confer only with other designated match officials concerning the behavior of any shooter and any scoring or penalty decisions to be rendered.
- 2.4.4.7 Ensure that the stage is reset in accordance with the CoF description and is consistent for all shooters.

2.5 IDPA Match Official (Chief Safety Officer Responsibilities)

- 2.5.1 The Chief Safety Officer (CSO) acts as the senior SO on the CoF and is responsible for running the CoF in accordance with IDPA rules and for supervising the CoF SO team. The CSO is designated by and directly accountable to the MD.
- 2.5.2 The CSO's specific responsibilities include:
 - 2.5.2.1 Overseeing the operation of the CoF SO Team. The CSO is responsible for the local allocation of PSO and SSO responsibilities to the CoF SO team members throughout the match.
 - 2.5.2.2 Prior to the start of match and periodically throughout the match, monitor the CoF, and coordinate changes with the Match Director if the CoF design, equipment, or environmental conditions result in a safety hazard.
 - 2.5.2.3 Assuring that a clear and consistent description of the CoF, including any muzzle safe points and other CoF safety criteria, is communicated to all shooters.
 - 2.5.2.4 Notify the Match Director to request a ruling when the Safety Officer team and shooter do not agree on a scoring or penalty assessment, taking any necessary steps to prevent the delay of the match.

2.6 IDPA Match Official (Primary Safety Officer Responsibilities)

- 2.6.1 The Primary Safety Officer (PSO) is responsible for preparing and running the shooter through the CoF in accordance with IDPA rules while monitoring the shoot's progress through the CoF and noting any infractions of IDPA rules. Primary SOs specific responsibilities include:
- 2.6.2 Maintaining a clear focus on the particular shooter the SO is assigned to observe, as follows:
 - 2.6.2.1 Not permitting his or her attention to be misdirected or lax.
 - 2.6.2.2 Observing the shooter during the CoF from a vantage point where the SO can clearly view each of the shooter's actions and react appropriately by the following means:
 - 2.6.2.2.1 Observe the firing hand and firearm.
 - 2.6.2.2.2 Note the shooter's body language and demeanor as it relates to predicting the shooter's actions.
 - 2.6.2.2.3 Accompany the shooter through the CoF without impeding the shooter's movements.
- 2.6.3 Help the shooter to complete the Course of Fire safely and enjoy the match while consistently enforcing the IDPA rules to ensure that the match is conducted in a fair and impartial manner.
- 2.6.4 Ensure that the CoF is administered and scored properly by:
 - 2.6.4.1 Directing the shooter through the CoF using proper range commands and timing the shooter's execution of the CoF.

2.6.4.2 Working in conjunction with the Scorekeeper SO to observe and levy any penalties incurred by the shooter during the CoF.

2.6.4.3 Coordinating with the Scorekeeper SO to ensure the shooter's time, score and any penalties are properly recorded.

2.7 IDPA Match Official (Scorekeeper SO Responsibilities)

2.7.1 The Scorekeeper SO (SSO) is the SO responsible for organizing and managing the shooting squad to maintain the smooth flow of the match, while allowing shooters as much flexibility as possible while preparing to shoot the CoF. The Scorekeeper SO is responsible for noting and properly recording the performance of the shooter during the CoF. The Scorekeeper SO's specific responsibilities include:

2.7.1.1 Be prepared to correct or stop the shooter during CoF execution, through use of the proper IDPA range commands, should it be required to maintain range safety.

2.7.1.2 Ensure the shooter's score is recorded accurately

2.7.1.2.1 Observe the shooter's execution of the CoF for safety, procedural, and cover violations

2.7.1.2.2 Ensure the shooter has the correct score sheet with the proper label, if applicable, and to write legibly.

2.7.1.2.3 Sign or initial the score sheet when the score is tallied, and initial any corrections made on score sheet.

2.7.1.2.4 Review the score sheet with the shooter, and provide an opportunity for the shooter to sign or initial the score sheet.

2.7.1.2.5 Give a copy of the score sheet to the shooter, if available.

2.7.1.3 Organize, manage, and stage the shooters to improve the "flow" of the match, and maintain squad and spectator control.

2.7.1.3.1 Announce the shooting order for the next three shooters to give the upcoming shooters time to prepare.

2.7.1.3.2 Stage the next ("on-deck") shooter in a pre-determined position so the Primary Safety Officer can begin to prepare the shooter while the stage is re-set and any administrative issues are concluded.

2.7.1.3.3 Handle all shooter administrative issues behind the firing line, allowing the Primary Safety Officer to finish preparing the next shooter.

2.8 Squad Safety Officer (SQSO) Guidelines

The Squad Safety Officer (SQSO) is the match official that has the most contact with competitors throughout an entire match, and can positively influence how people perform and feel about a match - before, during, and after shots are fired. The primary purpose of a Squad Safety Officer is to ensure the smooth, safe, and timely flow of squads through each stage and therefore the match. SQSOs will perform many of the administrative functions normally performed by competitors to allow competitors to concentrate more on their "match performance."

2.8.1 SQSOs perform a variety of functions within a match including:

- Preparing score sheets (affixing shooter labels to score sheets.)
- Establishing a fair and consistent rotating shooting order.
- Sorting stage score sheets in said order, including equitable splitting of the squad for bays with multiple stages to allow shooters the maximum amount of time between back to back stages.
- Acting as a general resource for shooters during the full course of the match by having at the ready, match information, locations, timing, etc.

- Help facilitate the timely resetting of stages, including ensuring that squad members are equally participating in the taping & resetting process, as appropriate.
- 2.8.2** SQSOs will meet their assigned squads immediately after the Match Director's shooters' brief and guide their squads to their first shooting bay, or be awaiting shooters at the designated bay.
- 2.8.3** SQSOs will attempt to answer all competitors' questions about the match and related post match events throughout the match. If an answer is not immediately available, the SQSO will obtain the proper information as soon as possible.
- 2.8.4** SQSOs must know, before the start of the match, the Match Director's match management strategy as to how he/she plans to run the match and any special instructions or emphasis for the match.
- 2.8.4.1** SQSOs must know match administration information at the start of the match including:
- The physical location of meeting places and location of Safe Areas and rest room facilities.
 - The location of the starting bay and subsequent bays in the order the squad will traverse the match.
 - Which bays with multiple stages will split the squad into groups or complete shooting each stage individually.
 - The intended flow sequence for each squad to include start and end times,
 - Timing and location for other planned events taking place before, during, and after the match such as the pre-match briefing, lunch, awards ceremonies, etc.
- 2.8.4.2** SQSOs should be provided with lists of all squad members (including name and competitor number) they are responsible for prior to the match start, and will ensure all competitors in their squads are accounted for throughout their portion of the match, to include at each bay and stage.

03 – Safety Officer (SO) Code of Conduct

- 3.1** I understand that it is a privilege, and not a right, to be an IDPA Safety Officer.
- 3.2** I will follow all of the safety rules of IDPA and the host range.
- 3.3** I recognize that it is my responsibility to maintain a thorough knowledge of the current IDPA rulebook.
- 3.4** Prior to and during the match, I will refrain from the use of alcohol, substances, or medications that may negatively impact my ability to perform the duties of a Safety Officer.
- 3.5** I will not communicate with others in a threatening, harassing or abusive manner.
- 3.6** I will be firm and fair in all judgment calls in the application of the IDPA rules. I will be prepared to state in a clear and concise manner my reasons for such calls to the shooter or any IDPA Official.
- 3.7** It is my duty to assist, to the best of my ability, all shooters and not to hinder them through harassment or authoritarian behavior.
- 3.8** I will represent my sport in a professional manner through my behavior and dress, in accordance with the standards established by the Match Director.
- 3.9** The integrity of the Safety Officer community should never be in doubt. I will refrain from any actions that could cause my honesty or objectivity to be questioned.
- 3.10** I will always be a champion for IDPA and promote IDPA in the best light possible.
- 3.11** I understand that violations of this code of conduct may result in my removal or disqualification from a match, loss of my privileges as an IDPA Safety Officer, and/or revocation of my IDPA membership.

04 – Safety Officer Instructor Roles & Responsibilities

4.1 IDPA Safety Officer Instructors

- 4.1.1** The IDPA Safety Officer Instructor (SOI) is a certified IDPA Safety Officer volunteer, who is responsible for the training and certification of IDPA Safety Officers. SOIs are veteran IDPA SOs who

have been recognized for their experience and excellence in performance as IDPA Safety Officers and, in addition, possess the ability to teach and motivate others.

4.2 IDPA Safety Officer Instructor Qualifications

4.2.1 All certified IDPA Safety Officer Instructors must meet and maintain the following requirements:

4.2.1.1 Be a current member in good standing of IDPA, and not have had your membership revoked.

4.2.1.2 Successfully complete the required IDPA SOI training or mentorship in accordance with current IDPA HQ policy.

4.2.1.3 Adhere to the IDPA Safety Officer Code of Conduct.

4.2.1.4 Regularly participate in IDPA matches as an SO at the club and sanctioned match levels.

4.2.1.5 Be actively involved in training and mentoring new IDPA Safety Officers on a regular basis.

4.2.1.6 Maintain their SOI certification via continuing SOI education and recertification every year in accordance with current IDPA HQ policy.

4.2.2 IDPA members interested in becoming IDPA Safety Officer Instructors must meet the following minimum qualifications to become an SOI:

4.2.2.1 Be a current member in good standing of IDPA, and never had your membership revoked.

4.2.2.2 Served as a certified IDPA SO in good standing for at least 3 consecutive years.

4.2.2.3 Be currently classified at Marksman or above in at least one IDPA division.

4.2.2.4 Served as a Safety Officer in two or more sanctioned IDPA matches within the past three years.

4.2.2.5 Demonstrated an exemplary knowledge of IDPA rules and procedures.

4.2.2.6 Be sponsored by at least one IDPA-affiliated club representative or IDPA Match Director and the IDPA Area Coordinator.

4.2.2.7 Be approved by the IDPA Board of Directors.

4.3 Safety Officer Instructor Responsibilities

4.3.1 The IDPA Safety Officer Instructor trains and certifies IDPA Safety Officer volunteers in accordance with the SO training policies and procedures established by the IDPA Board of Directors. The SOI has final discretion and authority in approving and certifying IDPA Safety Officer applicants and accepts the accountability for certifying to IDPA HQ that graduate SOs have the requisite attitude and ability to safely perform the basic duties of an IDPA Safety Officer.

4.3.2 In accepting and performing this important function within IDPA, the SOI has the following responsibilities:

4.3.2.1 Offer a minimum of three Safety Officer Classes every two years.

4.3.2.2 Present the class in accordance with current IDPA HQ guidelines, using the provided SO training materials.

4.3.2.3 Be willing to travel up to 250 miles within their Area (as determined by the Area Coordinator) to teach the SO Class.

4.3.2.4 Limit the fees charged for presenting SO Classes to the necessary and reasonable costs of conducting the class, including reimbursement for SOI travel and lodging costs.

4.3.2.5 Work with the Area Coordinator to identify and meet the SO needs of area IDPA clubs.

4.3.2.6 Demonstrate proficiency and current knowledge of IDPA rules through independent continuing SOI education.